



2024

OPHTHALMIC PRODUCTS

INSTRUMENTS | DRY EYE | SINGLE-USE | BIOLOGICS

Who is Stephens Instruments?

Established in 1976, Stephens Instruments has grown to become an industry-leading ophthalmic surgical instrument provider. A family-owned and operated company based in Lexington, Kentucky, USA, Stephens Instruments provides its full portfolio of **over 1000 products** to a global network of distributors in more than 50 countries around the world.

Stephens Instruments was founded on the philosophy of providing the highest quality products and unmatched customer service in the industry – all backed by an innovative design team keeping Stephens at the forefront of new surgical techniques introduced **over the past 45 years**.

Why choose Stephens?

Stephens Instruments' commitment to excellence in products and services is maintained with our certificate to ISO 13485, CE Marking, and FDA registration. Our emphasis on precision and value transfer directly to your practice with surgical instruments that will last for years to come. See why practitioners around the world have chosen Stephens Instruments and established relationships that were crafted to last a lifetime.

Lifetime Warranty

Stephens Instruments products are fully warrantied to the original owner against defects in materials and workmanship for the lifetime of the product. Any instrument with such a defect may be repaired or replaced free of charge. All unused Stephens Instruments products may be evaluated and returned for any reason during the first 30 days.

How to Order

Our team simplifies the ordering process and is here to work with you through any questions. Orders may be placed online or by contacting us through a method below:

Web: <https://stephensinst.com>

Email: info@stephensinst.com

Phone: **1-800-354-7848 or (+1)-859-259-4925**

Fax: **859-259-4926**



STEPHENS
INSTRUMENTS

Contents

Ophthalmic Reusable Instruments	3
S1 Speculums, Retractors	4
S2 Foreign Body Spuds, Alger Brush, Burrs	13
S3 Blade Breaker, Punches	15
S4 Curettes, Lens Loops, Spatulas, Manipulators, Hooks, Calipers, Phaco Choppers	16
S5 Forceps	42
S6 Needle Holders	78
S7 Scissors	84
S8 Probes & Dilators	96
S9 Markers	100
SC Cannulas	104
T Sterilization Trays	118
Titanium Reusable Instruments	120
Microsurgical Instruments	130
Instrument Sets	136
Lacriviera Punctal Plugs	174
Single-Use Instruments	188
Knives	197
Biologics	198

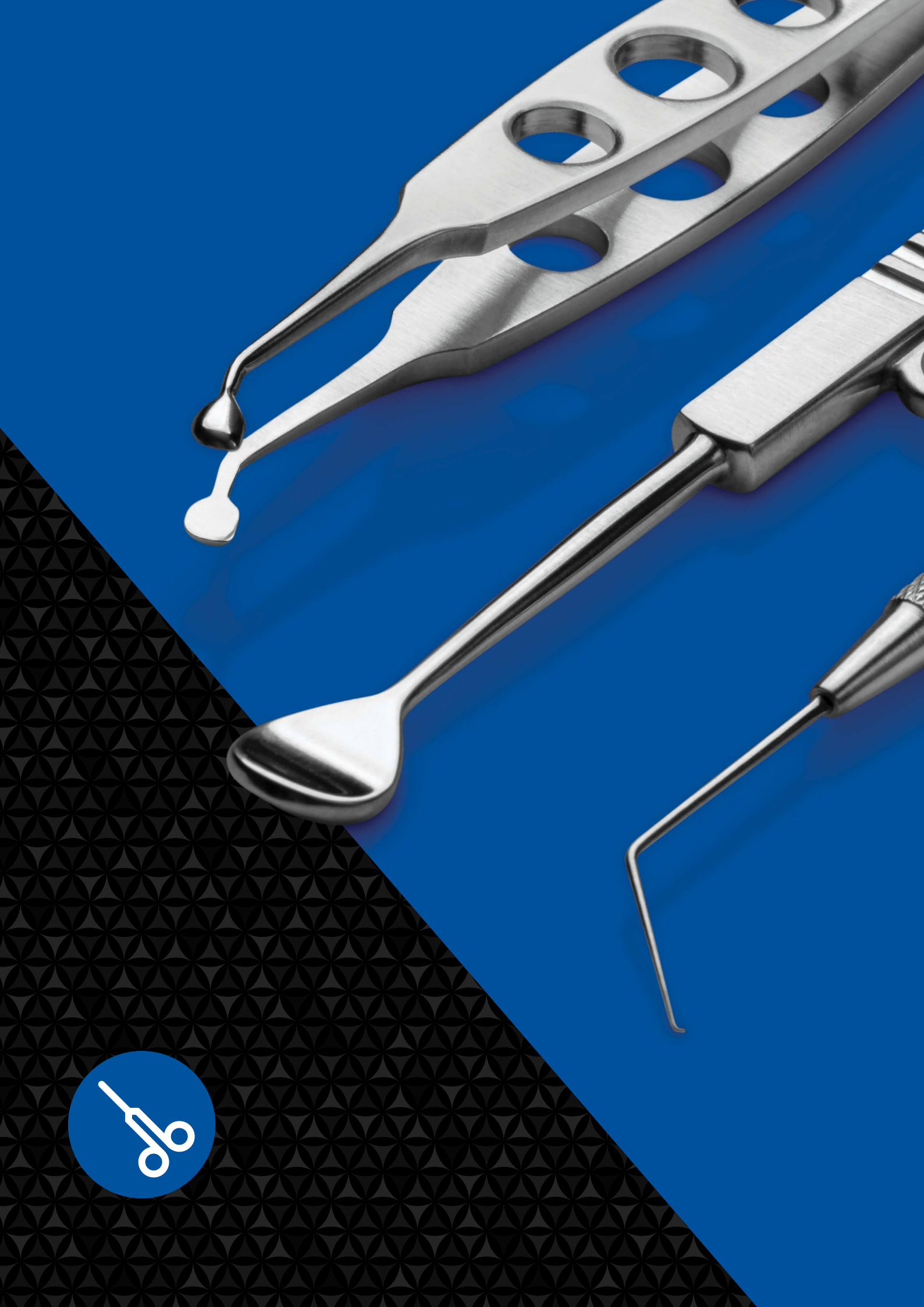

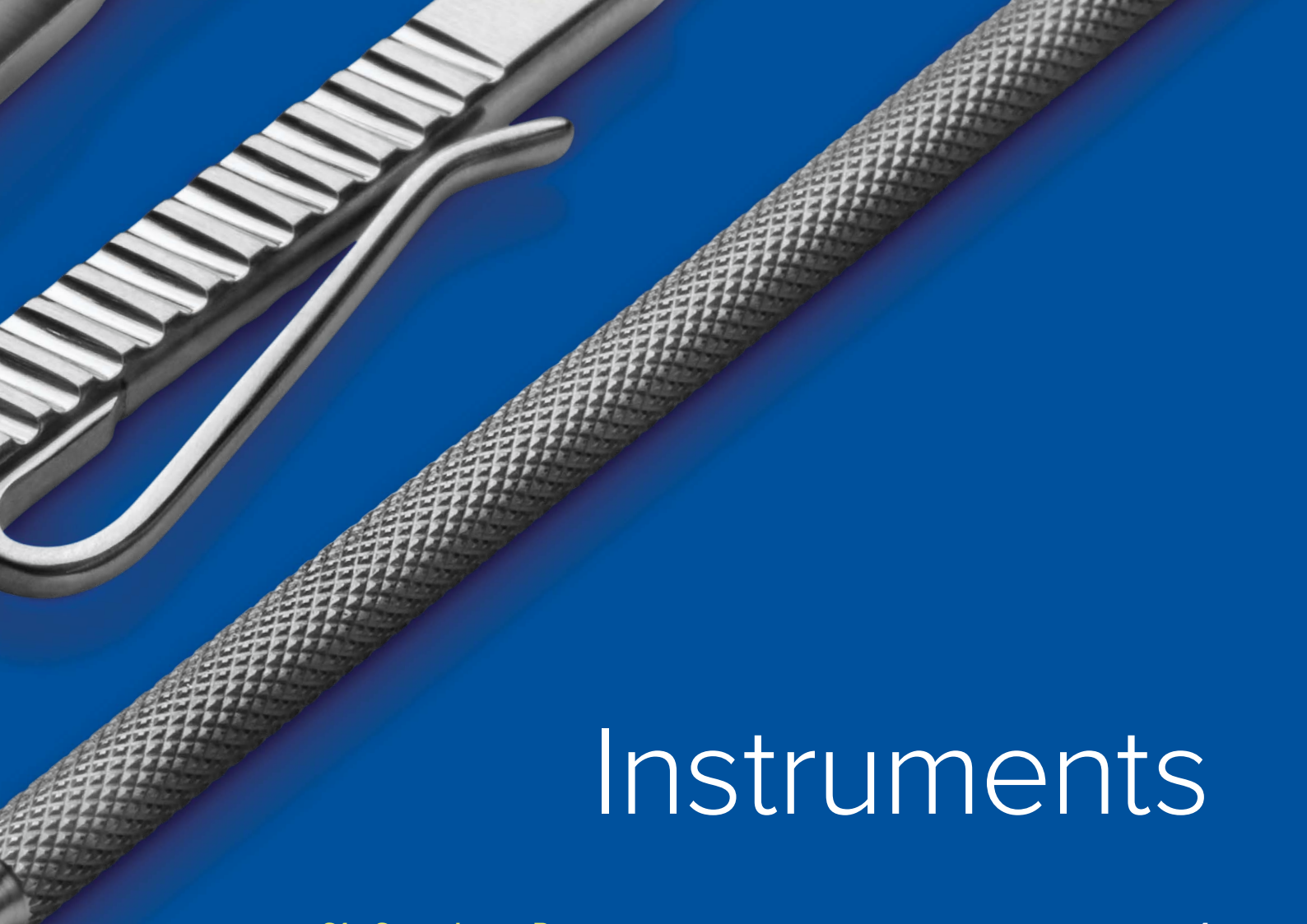

Instruments

S1	Speculums, Retractors	4
S2	Foreign Body Spuds, Alger Brush, Burrs	13
S3	Blade Breaker, Punches	15
S4	Curettes, Loops, Spatulas, Manipulators, Hooks	16
S5	Forceps	42
S6	Needle Holders	78
S7	Scissors	84
S8	Probes & Dilators	96
S9	Markers	100
SC	Cannulas	104
T	Trays	118

Newell Lid Retractor, Pair

S1-1000

Overall Length: 15mm
14mm Blades



Barraquer Wire Speculum

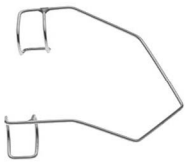

S1-1001

Infant, 4mm Blades
Overall Length: 31mm

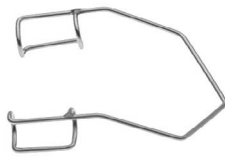

S1-1002

Child, 12mm Blades
Overall Length: 39mm

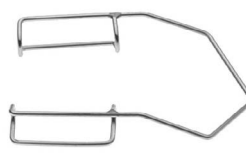

S1-1005

Adult, 15mm Blades
Overall Length: 41mm

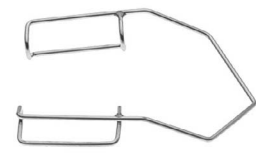

S1-1006

18mm Blades
Overall Length: 40mm

Slade LASIK Wire Speculum

S1-1003

Overall Length: 40mm
15mm Blades



Barraquer Wire Speculum, Solid Blades



S1-1009

Infant, 4mm Blades
Overall Length: 35mm



S1-1010

Child, 12mm Blades
Overall Length: 35mm

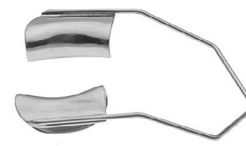

S1-1015

Adult, 15mm Blades
Overall Length: 42mm

Barraquer Wire Speculum

Nasal Approach

S1-1011 12mm Blades

Overall Length: 39mm

S1-1012 15mm Blades

Overall Length: 42mm

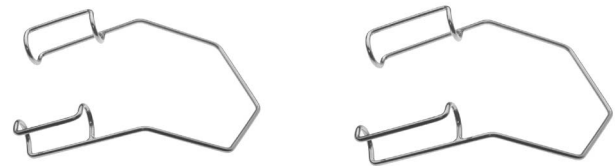

Barraquer Wire Speculum, Solid Blades

S1-1013

Overall Length: 42mm

Nasal Approach

15mm Blades



Lieberman Speculum

S1-1014K

Overall Length: 77mm

Nasal Approach

K-Wire, 15mm Blades



Lieberman Speculum

S1-1014S

Overall Length: 77mm

Nasal Approach

Solid Blade, 15mm Blades



Lieberman Speculum

S1-1014U

Overall Length: 77mm

Universal Approach

Solid Blade, 15mm Blades

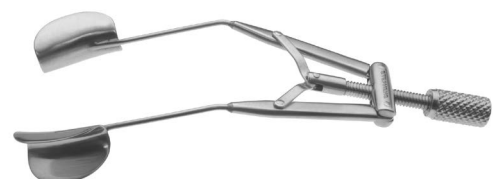

Lieberman Speculum

S1-1014V

Overall Length: 77mm

Nasal Approach

V-Wire, 15mm Blades



Kratz Wing Speculum

S1-1016

Overall Length: 38mm

Adult, 15mm Blades



Kratz Wing Speculum

S1-1018

Overall Length: 51mm

Fenestrated Blades

15mm Blades

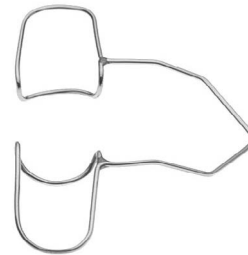

Grandon-Barraquer Speculum

S1-1020

Overall Length: 44mm

Wire Blade with Suture Notches

18mm Blades

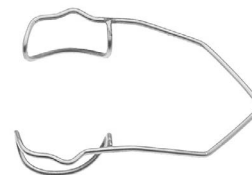

Stephens Irrigating Speculum

S1-1025

Overall Length: 86mm

Temporal Approach

15mm Blades

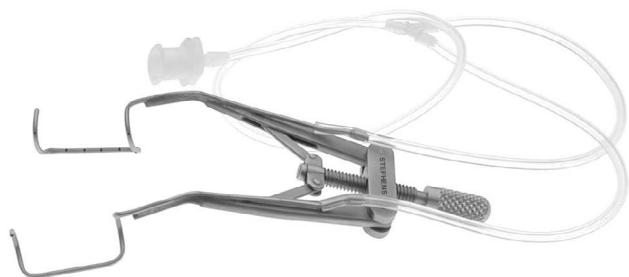

Lieberman Speculum

S1-1026

Overall Length: 82mm
K-Wire, Temporal Approach
15mm Blades



Lieberman Speculum

S1-1027

Overall Length: 81mm
V-Wire, Temporal Approach
15mm Blades



Lieberman Speculum

S1-1028

Overall Length: 78mm
Solid Blade, Temporal Approach
15mm Blades



Alfonzo Speculum

S1-1029

Overall Length: 44mm
Infant, 6mm Blades



Sauer Speculum

S1-1040 Infant, 6mm Blades

Overall Length: 30mm

S1-1045 Premature, 4mm Blades

Overall Length: 26mm



Cook Speculum



S1-1052

Solid Blades, 3mm
Overall Length: 35mm



S1-1054

Solid Blades, 6mm
Overall Length: 41mm



S1-1055

Solid Blades, 8mm
Overall Length: 44mm



S1-1056

Solid Blades, 11mm
Overall Length: 45mm



S1-1057

Solid Blades, 15mm
Overall Length: 55mm

Clark Universal Speculum

S1-1060

Overall Length: 80mm
15mm Blades

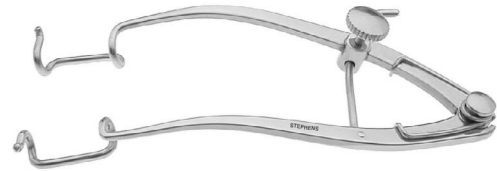

Castroviejo Speculum

S1-1065

Overall Length: 90mm
Fenestrated Blades, 15mm

S1-1066

Overall Length: 94mm
Fenestrated Blades, 16.5mm



Castroviejo Eye Speculum

S1-1067

Overall Length: 100mm
18mm Blades



Lancaster Speculum

S1-1070

Overall Length: 85mm
Solid Blades, 15mm



Lester-Burch Speculum

S1-1075

Overall Length: 84mm
Solid Blades, 15mm

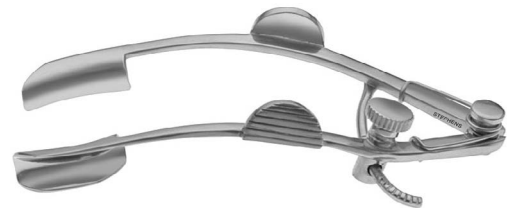

Williams Speculum

S1-1080 Child, 12mm Blades

Overall Length: 79mm

S1-1085 Adult, 15mm Blades

Overall Length: 85mm

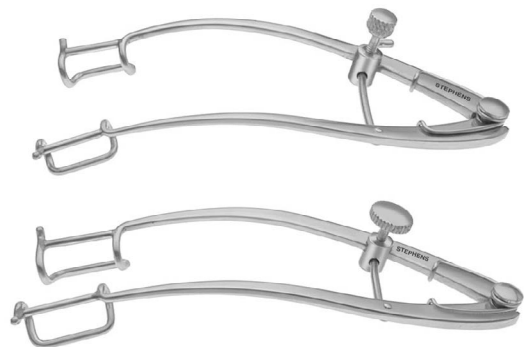

Maumenee-Park Speculum

S1-1120

Overall Length: 80mm
Fenestrated Blades
15mm Blades

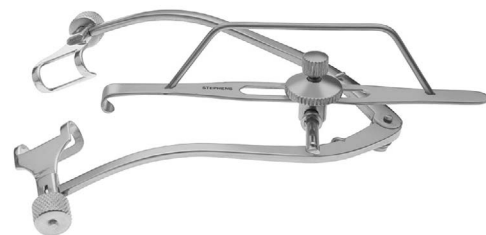

Jaffe Wire Retractor, Pair

S1-1137

Overall Length: 52mm
12mm Blades



Flieringa Fixation Ring

- S1-1155** 12mm
- S1-1160** 13mm
- S1-1165** 14mm
- S1-1170** 15mm
- S1-1175** 16mm
- S1-1180** 17mm
- S1-1185** 18mm
- S1-1190** 19mm
- S1-1195** 20mm
- S1-1200** 21mm
- S1-1205** 22mm



Thornton Fixation Ring

Swinging Handle

- S1-1211** Open Ring 1/4, 12mm
Overall Length: 116mm
- S1-1211A** Open Ring 1/2, 12mm
Overall Length: 116mm
- S1-1211B** Closed Ring, 14mm
Overall Length: 119mm

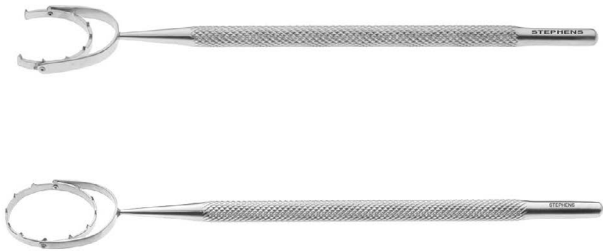

Desmarres Lid Retractor

- S1-1215** #0, 11mm
Overall Length: 140mm
- S1-1220** #1, 13mm
Overall Length: 143mm
- S1-1225** #2, 15mm
Overall Length: 144mm
- S1-1230** #3, 17mm
Overall Length: 146mm
- S1-1230A** Infant, 8.5mm
Overall Length: 138mm



Jaeger Lid Plate

- S1-1235**
Overall Length: 107mm



Agricola Retractor

S1-1240

Overall Length: 42mm
3x3 Prongs



Goldstein Retractor

S1-1245

Overall Length: 33mm

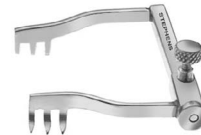

Muller Retractor

S1-1250

Overall Length: 65mm
3x3 Prongs
Lacrimal Sac



Stevenson Retractor

S1-1255

Overall Length: 88mm
3x3 Prongs



Stevenson Retractor

S1-1260

Overall Length: 85mm
Solid Blades, 15mm
Lacrimal Sac

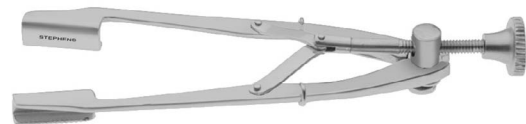

Fink Retractor

S1-1265

Overall Length: 128mm
4 Prongs
Angled, Blunt



Knapp Retractor

S1-1270

Overall Length: 133mm
4 Prongs, Blunt



Tenzel Double Ended Periosteal Elevator

S1-1275

Overall Length: 196mm



West Lacrimal Chisel

S1-1276 Straight

Overall Length: 135mm



S1-1277 Curved

Overall Length: 126mm



Wills Retractor

S1-1280

Overall Length: 136mm
6 Prongs, Sharp



Nasal Speculum



S1-1295

Infant
Overall Length: 129mm



S1-1296

Child
Overall Length: 126mm



S1-1297

Adult
Overall Length: 128mm

Wright Fascia Needle

S1-1310

Overall Length: 136mm



Tooke Corneal Knife

S2-1100

Overall Length: 114mm



Gill Corneal Knife

S2-1115

Overall Length: 124mm

Curved



Haab Scleral Knife

S2-1120

Overall Length: 122mm

5mm Tip



Foreign Body Needle

S2-1125 Straight

Overall Length: 120mm



S2-1130 Curved

Overall Length: 120mm



Dix Foreign Body Spud

S2-1131

Overall Length: 125mm



Golf Club Foreign Body Spud

S2-1135

Overall Length: 117mm

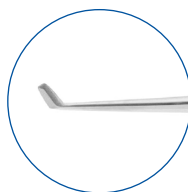

Ellis Foreign Body Spud**S2-1140**

Overall Length: 116mm

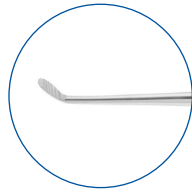
**Francis Foreign Body Spud****S2-1145**

Overall Length: 120mm

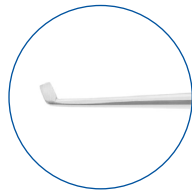
**La-Force Foreign Body Spud****S2-1150**

Overall Length: 120mm

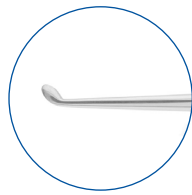
**Wills Eye Foreign Body Spud & Burr****S2-1155**

Overall Length: 109mm

**Stephens Eye Loop & Magnet****S2-1160**

Overall Length: 150mm



Alger Brush

Battery Included

- S2-1170** 1.0mm Tip,
- S2-1171** 0.5mm Tip,
- S2-1175** 1.0mm Tip, Burrs Only (5 pcs)
- S2-1175A** 0.5mm Tip, Burrs Only (5 pcs)



Pterygium Brush

Round Tip, Diamond Dusted, Battery Included

- S2-1176** 2.5mm, Fine Grit,
- S2-1177** 3.5mm, Medium Grit,
- S2-1178** Tip Only, 2.5mm, Fine Grit,
- S2-1179** Tip Only, 3.5mm, Medium Grit,



Castroviejo Blade Breaker

- S3-1000** With Lock

Overall Length: 115mm

- S3-1005** Without Lock

Overall Length: 99mm



Stephens Blade Breaker

- S3-1010**

Overall Length: 102mm

Small Square Jaws



Kelly Descemet Membrane Punch

S3-1036

Overall Length: 128mm
1.0mm Punch



Reiss Corneoscleral Punch

S3-1037

Overall Length: 87mm



Gass Punch

S3-1038

Overall Length: 89mm



Meyerhoefer Chalazion Curette

S4-1000 1.5mm

Overall Length: 132mm

S4-1001 0.5mm

Overall Length: 130mm

S4-1005 #1, 1.75mm

Overall Length: 132mm

S4-1010 #2, 2.25mm

Overall Length: 132mm

S4-1015 #3, 2.50mm

Overall Length: 132mm

S4-1020 #4, 3.50mm

Overall Length: 132mm



Open Ended Curette

S4-1000A 1.5mm

Overall Length: 110mm

S4-1005A 1.75mm

Overall Length: 102mm

S4-1010A 2.25mm

Overall Length: 104mm

S4-1015A 2.5mm

Overall Length: 100mm

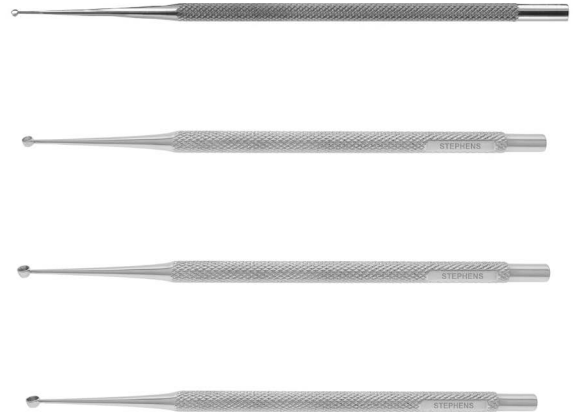

Weaver Curette

S4-1022

Overall Length: 90mm

Serrated



Nightingale Curette

S4-1023

Overall Length: 124mm

Capsule Polishing, Semi-Sharp



Skeel Chalazion Curette

S4-1030

Overall Length: 132mm

Serrated, 1.75mm



Barraquer Iris Spatula

15mm Angled Tip

S4-1039 Short Model, 0.4mm tip

Overall Length: 85mm

S4-1040 Smooth, Round. 0.4mm tip

Overall Length: 124mm

S4-1045 Smooth, Round, Delicate 0.3mm Tip

Overall Length: 124mm

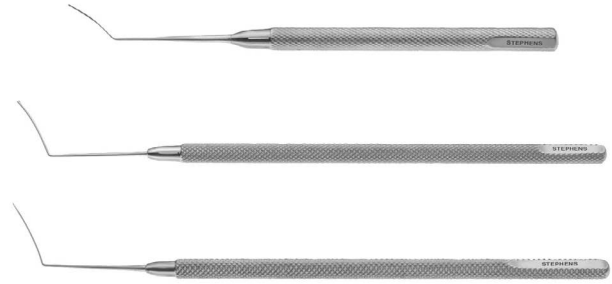

Culler Iris Spatula

S4-1055 1.0mm

Overall Length: 129mm

S4-1060 2.0mm

Overall Length: 130mm

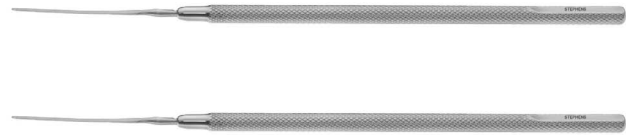

Kirby Iris Spatula

S4-1065

Overall Length: 128mm



Drysdale Nucleus Manipulator

S4-1068

Overall Length: 111mm

Paddle Shaped



Pisacano Nucleus Rotator

S4-1069

Overall Length: 115mm

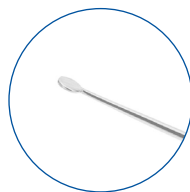

Bechert Nucleus Rotator**S4-1070**

Overall Length: 110mm

Angled

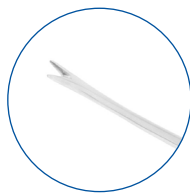
**Seipser Endocapsular Controller****S4-1071**

Overall Length: 116mm

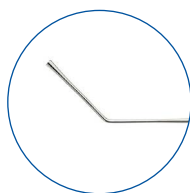
**Tennant Nucleus Manipulator****S4-1072**

Overall Length: 115mm

**Knolle Nucleus Spatula****S4-1075**

Overall Length: 124mm

Flat, 0.5mm

**Girard Synchiaie Spatula****S4-1080**

Overall Length: 117mm

0.5mm, Semi-Sharp



Galin Lens Spatula

S4-1085

Overall Length: 118mm
1.5mm Angled



Koch Phaco Manipulator

S4-1089

Overall Length: 115mm

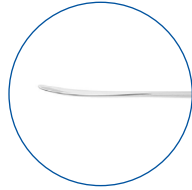

Hirschman Lens Spatula

S4-1090

Overall Length: 123mm
0.5mm, with Notches



Jaffe Lens Spatula

S4-1095

Overall Length: 122mm
0.5mm, Angled



Obstbaum Synechia Spatula

S4-1100

Overall Length: 119mm
0.25mm



Maumenee-Barraquer Spatula

S4-1116

Overall Length: 120mm
Vitreous, Right



Castroviejo Synecchia Spatula

0.5mm

S4-1120 Sharp

Overall Length: 139mm

S4-1125 Semi-Sharp

Overall Length: 137mm



Castroviejo Cyclodialysis Spatula

S4-1130 0.25mm Wide

Overall Length: 142mm

S4-1135 0.50mm Wide

Overall Length: 141mm

S4-1140 0.75mm Wide

Overall Length: 142mm



Dastoor Pupil & Iris Repositor

S4-1145

Overall Length: 133mm

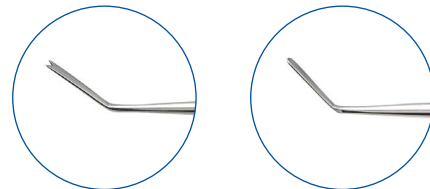

Elschnig Cyclodialysis Spatula

S4-1150

Overall Length: 133mm



Barraquer Lenticular Spoon

S4-1151

Overall Length: 124mm



Castroviejo Spatula & Spoon

S4-1153

Overall Length: 133mm



Paton Double Spatula

S4-1154

Overall Length: 135mm

2mm Tip



Kimura Platinum Spatula

S4-1155

Overall Length: 149mm



Gills/Welsh Lens Loop

S4-1156

Overall Length: 117mm



Lens Loop

S4-1157

Overall Length: 133mm

Fine



Morrison Lens Loop & Probe

S4-1158

Overall Length: 149mm



Lewis Lens Loop

S4-1160 Small

Overall Length: 135mm

S4-1165 Large

Overall Length: 139mm



New Orleans Lens Loop

S4-1170

Overall Length: 139mm



Kirby Intracapsular Lens Loop

S4-1171

Overall Length: 135mm



Snellen Lens Loop

S4-1175

Overall Length: 140mm



Weber Lens Loop

S4-1180

Overall Length: 140mm



Wilder Serrated Lens Loop

S4-1185

Overall Length: 140mm



Simcoe Double Lens Loop

S4-1191

Overall Length: 137mm



Bunge Evisceration Spoon

S4-1200 Small, 8mm

Overall Length: 131mm

S4-1205 Medium, 10mm

Overall Length: 139mm

S4-1210 Large, 12mm

Overall Length: 142mm



Wells Enucleation Spoon

S4-1215

Overall Length: 145mm



Arruga Retractor

S4-1220

Overall Length: 144mm

11mm Blade



Schocket Scleral Depressor

S4-1231

Overall Length: 135mm



Schepens Scleral Depressor

S4-1232

Overall Length: 49mm
Thimble



Josephberg-Besser Scleral Depressor

S4-1236 Double-Ended

Overall Length: 138mm

S4-1236S Single-Ended

Overall Length: 100mm



Schepens Orbital Retractor

S4-1260

Overall Length: 154mm



Baker Orbital Retractor Set

S4-1261

Overall Length: 155mm
Malleable (Set of 3)



Tyrell Iris Hook

S4-1270 Sharp

Overall Length: 121mm

S4-1275 Blunt

Overall Length: 124mm

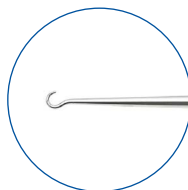
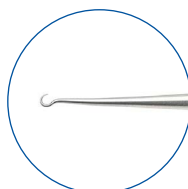

Fixation Hook

Sharp

S4-1280 Small

Overall Length: 129mm

S4-1285 Large

Overall Length: 132mm

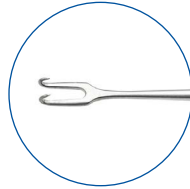
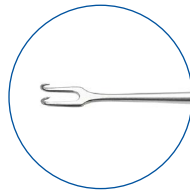

Scleral Hook

S4-1290

Overall Length: 110mm

Twist Fixation

0.5mm, Right

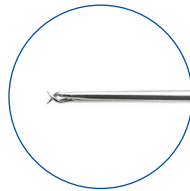

Burch Fixation Pick

S4-1310

Overall Length: 135mm

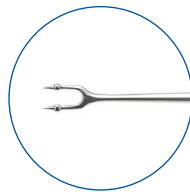

Bonn Micro Iris Hook

S4-1315 Round Handle, with Guard

Overall Length: 125mm

S4-1320 Blunt, Flat Handle

Overall Length: 126mm

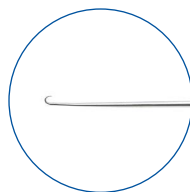
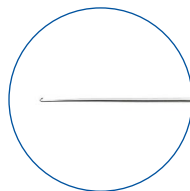

Graether Collar Button

S4-1325 Straight
Overall Length: 119mm

S4-1326 Angled
Overall Length: 123mm

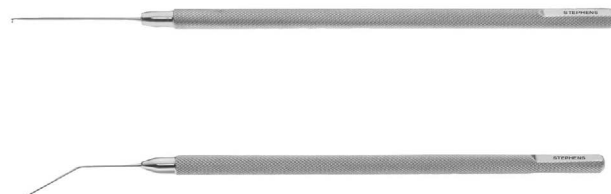
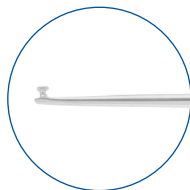

Sheets Micro Hook

S4-1330
Overall Length: 124mm
Sharp, with Guard

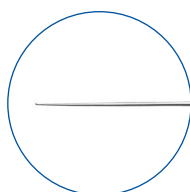

Hirschman Iris Hook

S4-1345
Overall Length: 117mm
Lens Manipulator, Blunt

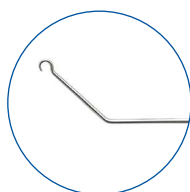

Ford Microstent Manipulator

S4-1350
Overall Length: 109mm
0.3mm Tip

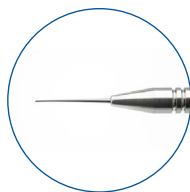

Kuglen Iris Hook & Lens Manipulator

S4-1360
Overall Length: 113mm
Clover Leaf, Straight

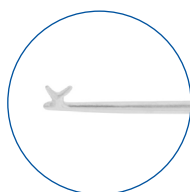

Kuglen Iris Hook

Push-Pull Model

S4-1365 Straight

Overall Length: 112mm

S4-1370 Angled

Overall Length: 111mm

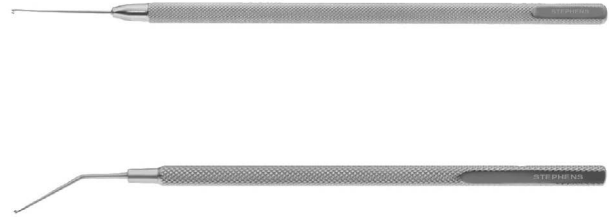
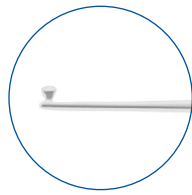

Grayson/Kuglen Double-Ended Manipulator

S4-1369

Overall Length: 137mm

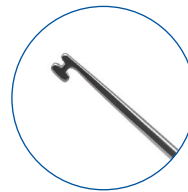

Lester Lens Manipulator

S4-1371 Straight

Overall Length: 116mm

S4-1372 Angled

Overall Length: 114mm

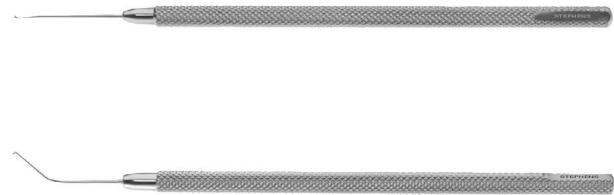
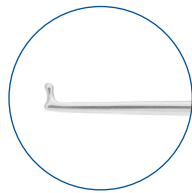

Fenzl Lens Manipulating Hook

S4-1373 Straight

Overall Length: 114mm

S4-1374 Angled

Overall Length: 116mm

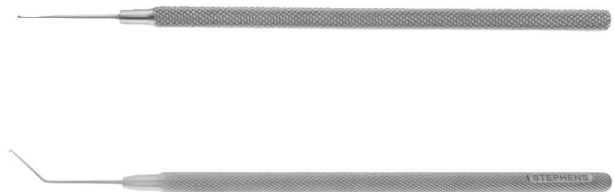
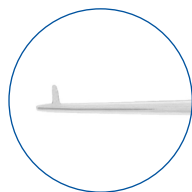

Harris-Sinskey Lens Hook

S4-1375

Overall Length: 116mm
Angled, Blunt



Lewicky Lens Manipulating Hook

S4-1376

Overall Length: 117mm
0.15mm Tip
Curved

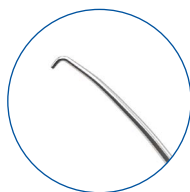

Rainin Lens Hook

S4-1380

Overall Length: 125mm
Blunt

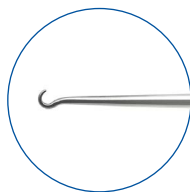

Fugo Z-Hook Lens Manipulator

S4-1381

Overall Length: 114mm

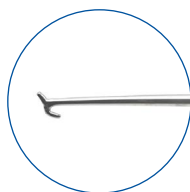

Rentsch & Boat Hook & Lens Manipulator

S4-1382

Overall Length: 114mm

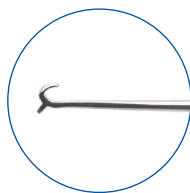

Maltzman-Fenzl Lens Manipulator Hook

V-Shaped

S4-1383 Straight

Overall Length: 118mm

S4-1384 Angled

Overall Length: 117mm

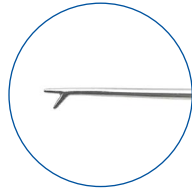

Sinskey II Lens Hook

0.18mm Tip

S4-1386 Straight

Overall Length: 112mm

S4-1387 Angled

Overall Length: 111mm

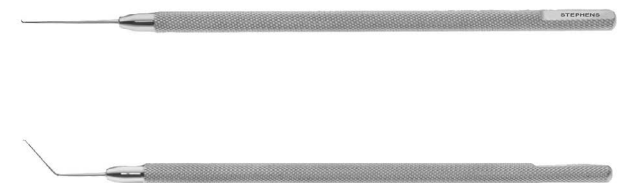

Sinskey II Lens Manipulating Hook

S4-1390

Overall Length: 116mm

For A/C Lenses

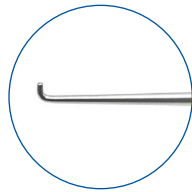

Galand Lens Manipulating Hook

S4-1391

Overall Length: 117mm

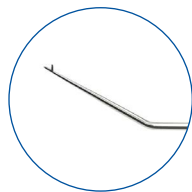

Jaffe-Maltzman Lens Hook

S4-1392

Overall Length: 116mm

Angled, V-Shaped

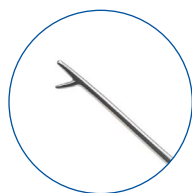

Osher Y-Hook IOL Manipulator

S4-1393

Overall Length: 119mm
Straight

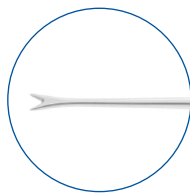

Tennant Manipulating Hook

S4-1395

Overall Length: 120mm
For A/C Lenses

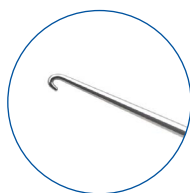

Stephens Phaco Nucleus Splitter

S4-1396

Overall Length: 115mm



Osher Nucleus Splitter

S4-1396M

Overall Length: 116mm



Reverse Sinskey Hook

S4-1397

Overall Length: 119mm
DSEK



O'Conner Tenotomy Hook

S4-1400

Overall Length: 129mm

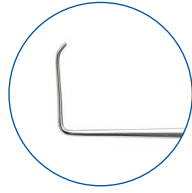

Stevens Tenotomy Hook

S4-1405

Overall Length: 121mm

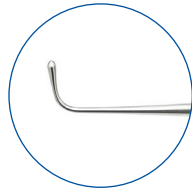

Graefe Muscle Hook

S4-1410 #3, Large

Overall Length: 141mm

S4-1415 #2, Medium

Overall Length: 140mm

S4-1420 #1, Small

Overall Length: 134mm

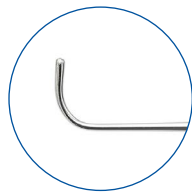
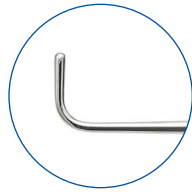
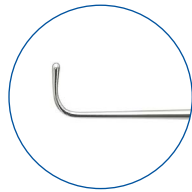

Culler Rectus Muscle Hook

S4-1425

Overall Length: 123mm

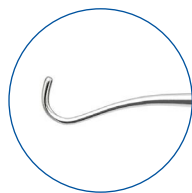

Jameson Muscle Hook

S4-1430 Small, 10mm

Overall Length: 129mm

S4-1435 Large, 12mm

Overall Length: 134mm

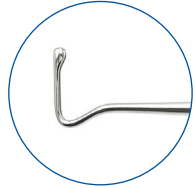
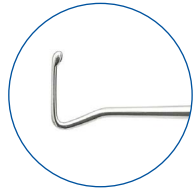

Kirby Expressor Hook & Loop

S4-1439

Overall Length: 141mm

5mm Diameter

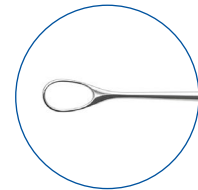
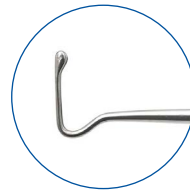

Kirby Muscle Hook

S4-1440 Single-Ended

Overall Length: 134mm

S4-1441 Double-Ended

Overall Length: 134mm

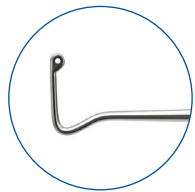

McCreynolds Spatula & Hook

S4-1442

Overall Length: 128mm

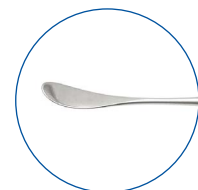
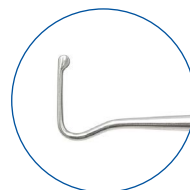

Strabismus Hook**S4-1443**

Overall Length: 149mm

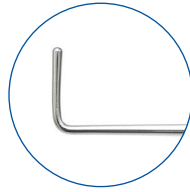
**Green Muscle Hook****S4-1445**

Overall Length: 130mm

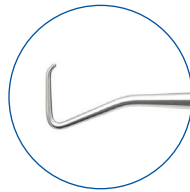
**Green Spatula****S4-1446**

Overall Length: 125mm

Double-Ended

**Manson Double Ended Hook****S4-1448**

Overall Length: 126mm

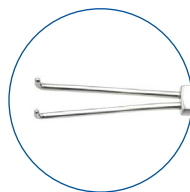
**Mccannel Iris Suture Needle Guide****S4-1450**

Overall Length: 112mm

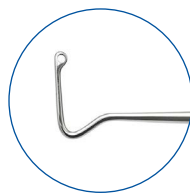

Castroviejo Caliper

S4-1455 Straight, 20mm

Overall Length: 85mm

S4-1456 Curved, 20mm

Overall Length: 82mm

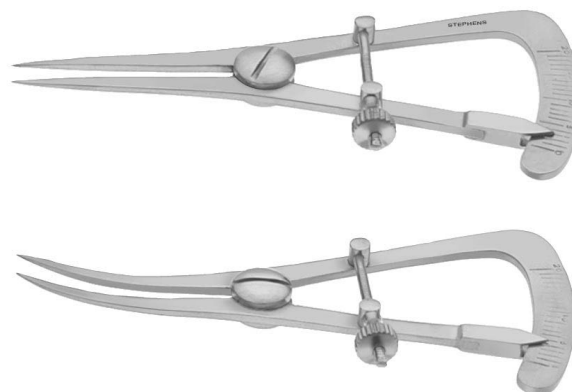

Braunstein Caliper

S4-1457

Overall Length: 67mm

3.5mm / 4.0mm



Stainless Steel Ruler

S4-1490

Overall Length: 150mm

0.5mm Marking

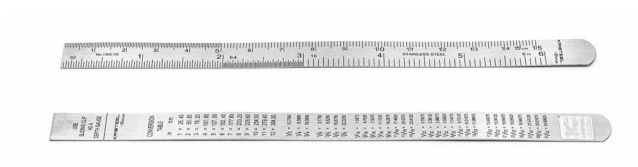

Kansas Nucleus Trisector

S4-1540

Overall Length: 110mm

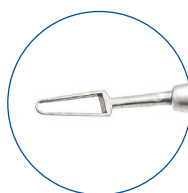

Nagahara Horizontal Chopper

S4-1550

Overall Length: 112mm



Nichamin Quick Chop Verticle Chopper**S4-1551**

Overall Length: 112mm

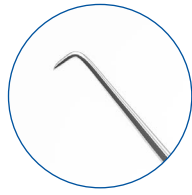
**Koch Stop And Chop Manipulator****S4-1552**

Overall Length: 113mm

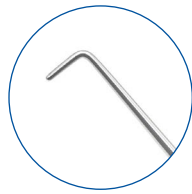
**He Hook Chopper****S4-1553**

Overall Length: 112mm

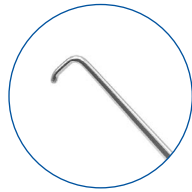
**Chang-Seibel Chopper****S4-1554**

Overall Length: 136mm

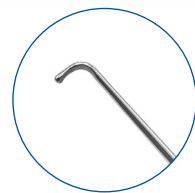
**Rosen Phaco Splitter****S4-1556**

Overall Length: 113mm

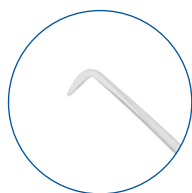

Seibel Nucleus Chopper

S4-1557

Overall Length: 117mm



Chang Combination Microfinger Horizontal & Quick Chop

S4-1558

Overall Length: 140mm



Chang Horizontal Microfinger Chopper

S4-1559

Overall Length: 112mm



Connor Wand

S4-1560

Straight

Overall Length: 117mm

S4-1565

Curved

Overall Length: 117mm



Anis Ball Tip Manipulator

S4-1570

Overall Length: 115mm

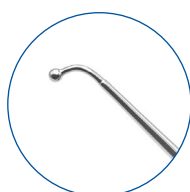

Guimaraes LASIK Spatula

S4-1600

Overall Length: 118mm



Fukasaku Lasik Spatula

S4-1605

Overall Length: 117mm



Seibel Intralase Separator-Elevator

S4-1609

Overall Length: 112mm

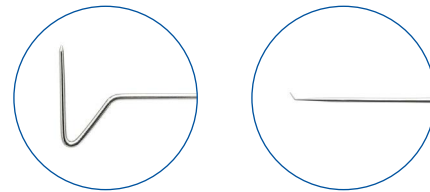

Slade Flap Spatula, Blunt

S4-1610

Overall Length: 131mm



Slade LASIK Retreatment

S4-1615

Overall Length: 123mm

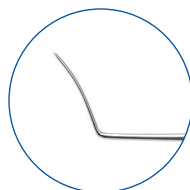

Herzing LASIK Elevator/Retractor

S4-1620

Overall Length: 147mm

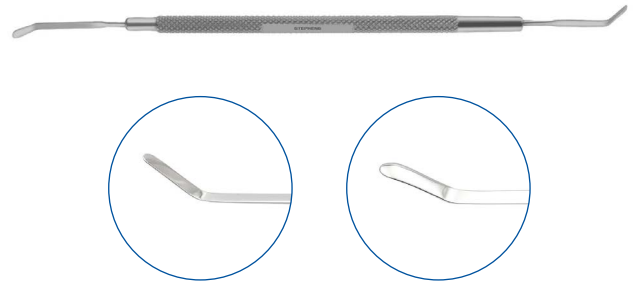

KU LASIK Flap Elevator/Manipulator

S4-1625

Overall Length: 128mm

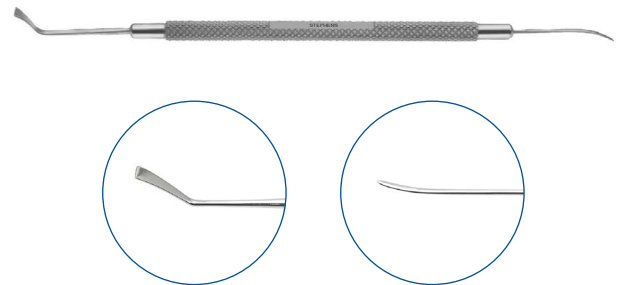

Machat LASIK Retreatment

S4-1630

Overall Length: 124mm

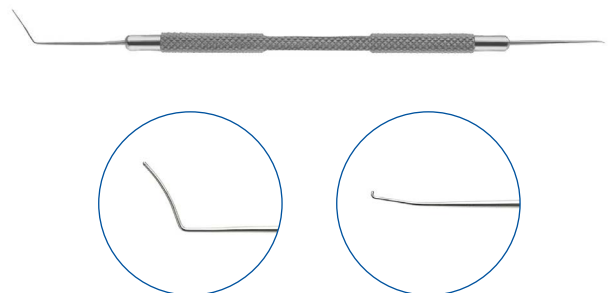

Osher Utility Hook

S4-1640

Overall Length: 116mm



Buratto Flap Protector

S4-1660

Overall Length: 114mm



Katzen LASIK Flap Unzipper

S4-1665

Overall Length: 112mm

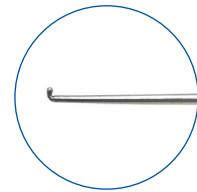
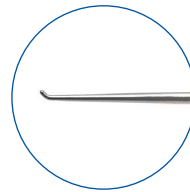

Endothelial Stripper

S4-1670

Overall Length: 124mm

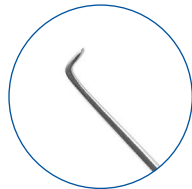

Corneal Epithelium Spatula-Hockey Stick

S4-1675

Overall Length: 123mm

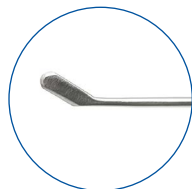

Double Ended Femtosecond Spatula

S4-1700

Overall Length: 141mm

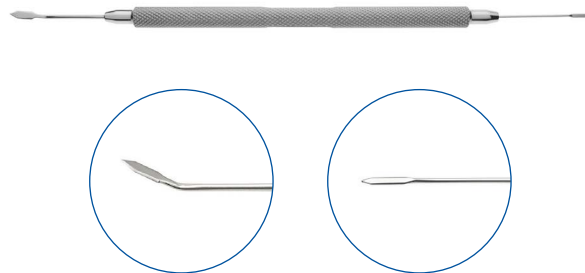

Solomon Femto Chopper

S4-1710

Overall Length: 114mm

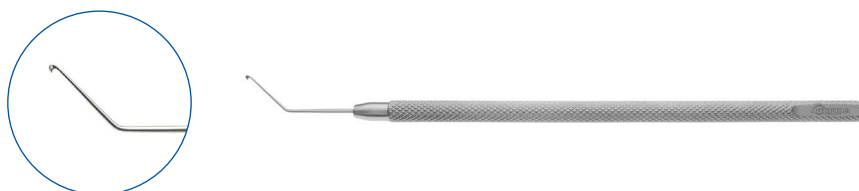

SMILE Double Ended Dissector

S4-1715

Overall Length: 127mm

Lenticle Manipulator

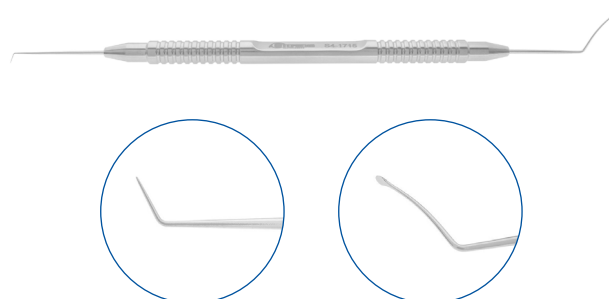

Seibel II

S4-1720

Overall Length: 103mm

Intralase Flap Lifter & Retreatment Spatula

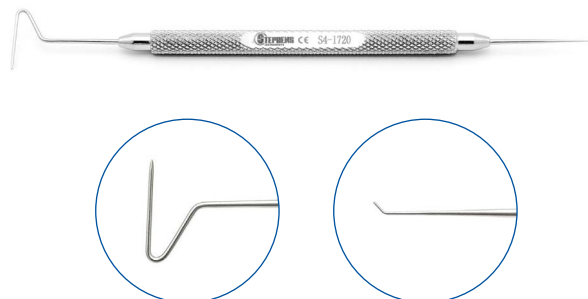

Ayer Chalazion Forceps

9mm

S5-1000 With Screw

Overall Length: 92mm

S5-1005 Without Screw

Overall Length: 91mm



Baird Chalazion Forceps

S5-1010

Overall Length: 96mm

8x12mm



Dolmetsch Ptosis Clamp

S5-1014

Overall Length: 100mm

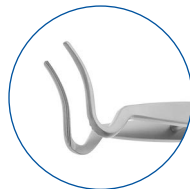

Berke Ptosis Forceps

S5-1015 20mm Jaws

Overall Length: 99mm

S5-1016 27mm Jaws

Overall Length: 101mm



Entropian Forceps

S5-1017 Right

Overall Length: 101mm

S5-1018 Left

Overall Length: 101mm



Cauer Chalazion Forceps

S5-1020

Overall Length: 96mm
with Serrations
12x9mm



Desmarres Chalazion Forceps

S5-1025 12x20mm

Overall Length: 91mm

S5-1030 16x24mm

Overall Length: 95mm

S5-1035 20x30mm

Overall Length: 101mm



Erhardt Lid Forceps

S5-1040

Overall Length: 96mm
14x20mm



Francis Chalazion Forceps

S5-1045

Overall Length: 96mm
12x14mm



Heath Chalazion Forceps

S5-1050

Overall Length: 99mm
12x14mm



Hunt Chalazion Forceps

S5-1055

Overall Length: 92mm
12mm

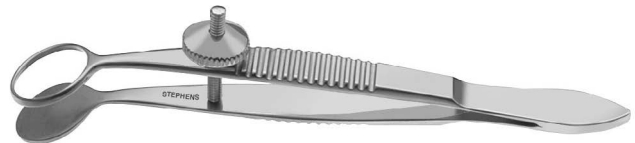

Lacriviera Meibomian Gland Expressor

S5-1057

Overall Length: 92mm
9mm



Stephens Meibomian Gland Expressor

S5-1058

Overall Length: 102mm
Paddle Width: 3.25mm



Stephens Intracanalicular Plug Forceps

S5-1059

Overall Length: 111mm

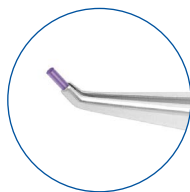

Lambert Chalazion Forceps

S5-1060 Small, 8mm

Overall Length: 91mm

S5-1065 Large, 11mm

Overall Length: 95mm



Lordan Chalazion Forceps

S5-1070

Overall Length: 93mm

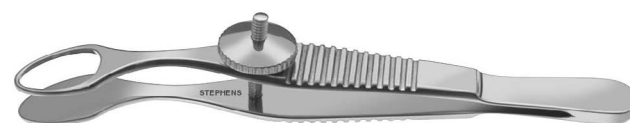

Wiese Chalazion Forceps

S5-1080

Overall Length: 96mm

Serrated Jaws

12x8mm



Barraquer Cilia Forceps

S5-1085

Overall Length: 108mm

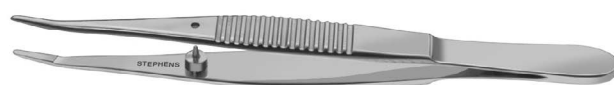
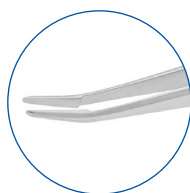

Stephens Cilia Forceps

S5-1086

Overall Length: 87mm



Beaupre Cilia Forceps

S5-1090

Overall Length: 113mm



Stephens Cilia Forceps

S5-1095 1mm

Overall Length: 81mm

S5-1100 2mm

Overall Length: 82mm

S5-1105 3mm

Overall Length: 82mm



Gradle Cilia Forceps

S5-1110

Overall Length: 100mm



Barraquer Colibri Forceps

S5-1120

Overall Length: 70mm

Tying Platform

1x2 Teeth, 0.12mm

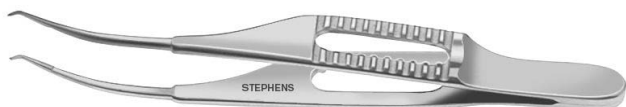
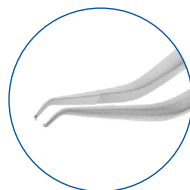

Colibri Forceps**S5-1125**

Overall Length: 75mm
 45 Degree Angled
 1x2 Teeth, 0.12mm

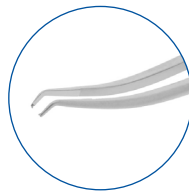
**Colibri Forceps****S5-1130**

Overall Length: 73mm
 1x2 Teeth, 0.1mm
 Straight

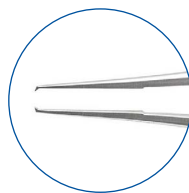
**Gills Colibri Forceps****S5-1131**

Overall Length: 72mm
 Fine Tip

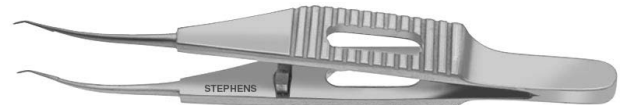
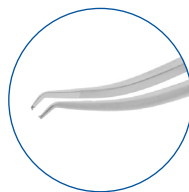
**Colibri Forceps****S5-1135**

Overall Length: 74mm
 Tying Platform
 1x2 Teeth, 0.4mm

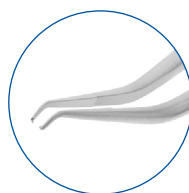
**Colibri Forceps****S5-1140**

Overall Length: 102mm
 Round Handle
 1x2 Teeth, 0.12mm

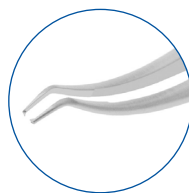

Castroviejo Colibri Forceps

S5-1145

Overall Length: 107mm

Tying Platform

1x2 Teeth, 0.12mm

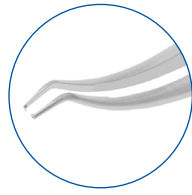

Harms Colibri Forceps

S5-1150

Overall Length: 73mm

Tying Platform

1x2 Teeth, 0.12mm

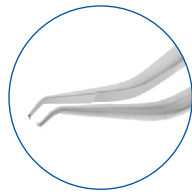

Colibri Forceps

S5-1155

Overall Length: 101mm

Tying Platform

Set at 45deg

1x2 Teeth, 0.12mm

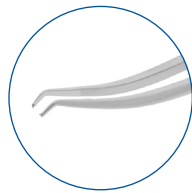

Maumenee Colibri Forceps

1x2 Teeth, 0.1mm

S5-1160 90 Degree Angled

Overall Length: 117mm

S5-1161 Set at 45deg

Overall Length: 119mm

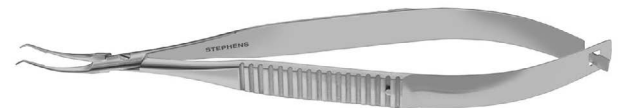
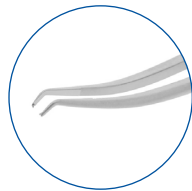
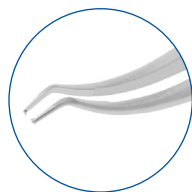

Pierce Colibri Forceps**S5-1165**

Overall Length: 72mm
 Tying Platform
 0.1mm Hole

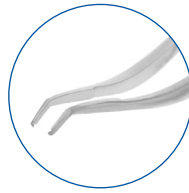
**Tennant Colibri Forceps****S5-1175**

Overall Length: 121mm
 Tying Platform
 1x2 Teeth, 0.12mm

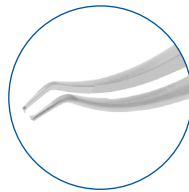
**Stephens Corneal Forceps****S5-1176**

Overall Length: 126mm
 Pierce Hole behind Teeth
 1x2 Teeth, 0.12mm

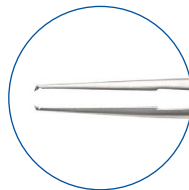
**Troutman-Barraquer Colibri Forceps****S5-1180**

Overall Length: 72mm
 Tying Platform
 1x2 Teeth, 0.12mm

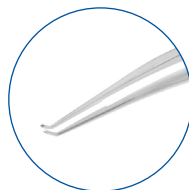
**Girard Corneoscleral Forceps**

1x2 Teeth, 0.12mm

S5-1185 Right

Overall Length: 101mm

S5-1190 Left

Overall Length: 101mm

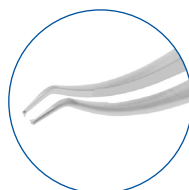

Hyde Corneal Forceps

S5-1195

Overall Length: 100mm
2x2 Teeth, 0.12mm

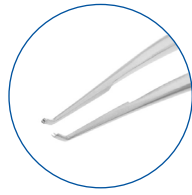

Stevens Corneoscleral Forceps

S5-1193

Overall Length: 104mm
1x2 Teeth, 0.12mm

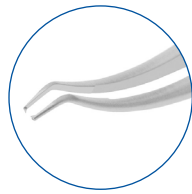

Pierse Corneal Forceps

0.1mm Hole

S5-1200 Straight, Delicate

Overall Length: 109mm

S5-1205 Curved

Overall Length: 107mm

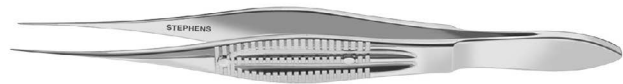
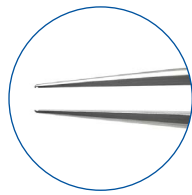

Cohan Corneal Forceps

S5-1210

Overall Length: 64mm
1x2 Teeth, 0.12mm

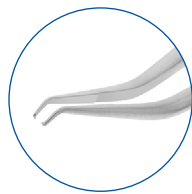

Hoffer-McPherson Corneal Forceps

S5-1215

Overall Length: 104mm
1x2 Teeth, 0.12mm
Angled

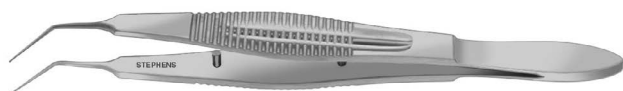
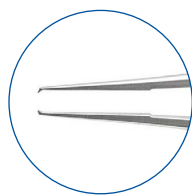

Kelman-McPherson Forceps

S5-1220

Overall Length: 104mm
1x2 Teeth, 0.3mm
Angled

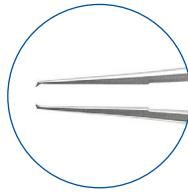

McPherson Corneal Forceps

1x2 Teeth, 0.4mm

S5-1225 Straight

Overall Length: 108mm

S5-1230 Angled

Overall Length: 107mm

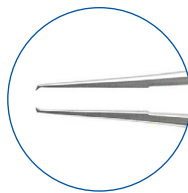

Thorpe Corneal Forceps

S5-1235

Overall Length: 108mm
2x3 Teeth, 0.12mm



DMEK Endothelium Forceps

S5-1236

Overall Length: 100mm

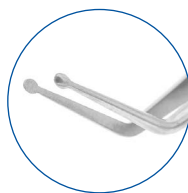

Bonn Forceps

1x2 Teeth, 0.12mm

S5-1240 Long Model

Overall Length: 109mm

S5-1245 Short Model

Overall Length: 83mm

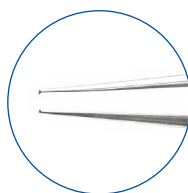

Bonn Forceps

Serrated Jaws

S5-1250 Straight

Overall Length: 75mm

S5-1255 Angled

Overall Length: 75mm

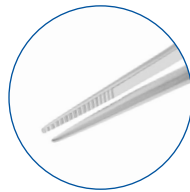

Bonn Forceps

1x2 Teeth, 0.12mm

S5-1260 Straight

Overall Length: 76mm

S5-1265 Angled

Overall Length: 72mm

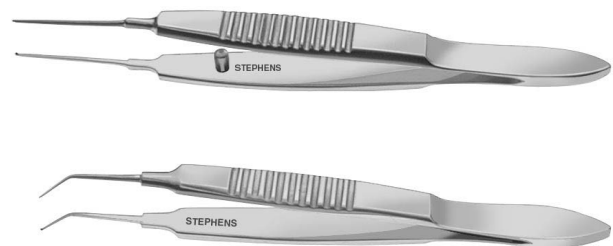
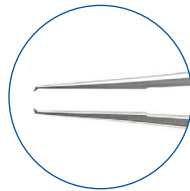

Bonn Forceps

S5-1270

Overall Length: 95mm

1x2 Teeth, 0.12mm

Tying Platform

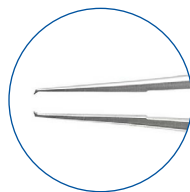

Graefe Iris Forceps

S5-1266 1x2 Teeth, 0.12mm

Overall Length: 72mm

S5-1267 Serrated, Curved

Overall Length: 73mm

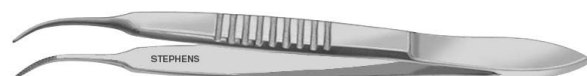
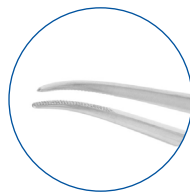
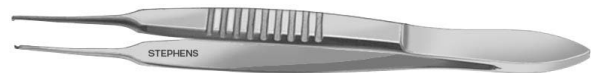
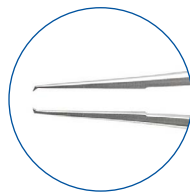

Botvin Forceps

S5-1275

Overall Length: 71mm
1x2 Teeth, 0.12mm

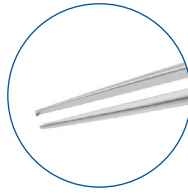

Gill Iris Forceps

Curved

S5-1285 1x2 Teeth, 0.3mm

Overall Length: 75mm

S5-1290 Serrated Jaws

Overall Length: 71mm

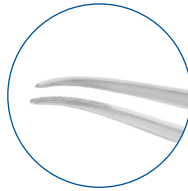
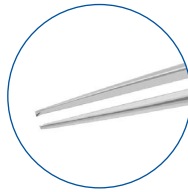

Iris Forceps

S5-1295

Overall Length: 70mm
Serrated, Straight



Iris Forceps

S5-1300

Overall Length: 73mm
Serrated Jaws
Curved

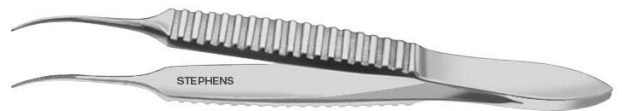
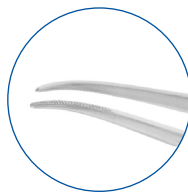

Iris Forceps

S5-1305

Overall Length: 95mm
Fine Teeth, Long Handle
1x2 Teeth, 0.12mm



Iris Forceps**S5-1315**

Overall Length: 90mm
 Fine Teeth, Long Handle
 Long Curve
 1x2 Teeth, 0.12mm

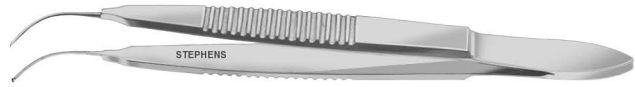
**Iris Forceps****S5-1330**

Overall Length: 74mm
 1x2 Teeth, 0.1mm

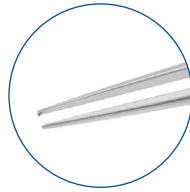
**Bishop-Harmon Iris Forceps****S5-1340**

Overall Length: 83mm
 Criss-Cross Serrated

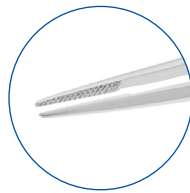
**Fischer-Arlt Iris Forceps****S5-1345**

Overall Length: 61mm
 1x2 Teeth, 0.12mm

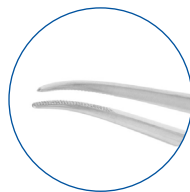
**Macgregor Conjunctiva Forceps****S5-1355**

Overall Length: 107mm
 Tying Platform
 Serrated

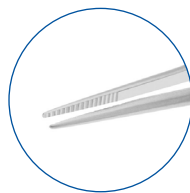

Barraquer Conjunctiva Forceps

S5-1360

Overall Length: 75mm
Tying Platform
Serrated

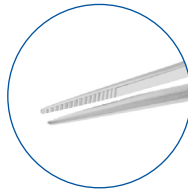

Bishop-Harmon Forceps

1x2 Teeth

S5-1365 Standard, 0.8mm

Overall Length: 85mm

S5-1370 Fine, 0.3mm

Overall Length: 84mm

S5-1371 Delicate, 0.12mm

Overall Length: 84mm

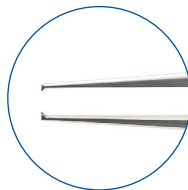
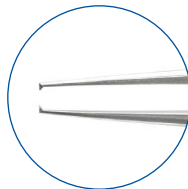
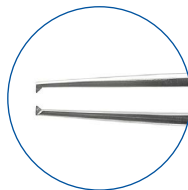

Dressing Forceps

Serrated, w/ Guide Pin

S5-1375 Straight

Overall Length: 98mm

S5-1380 Curved

Overall Length: 100mm

S5-1381 Strong Curve

Overall Length: 96mm

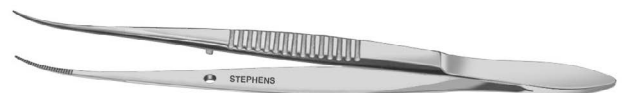
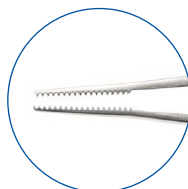

Adson Forceps

S5-1382

Overall Length: 117mm
1x2 Teeth, 0.3mm

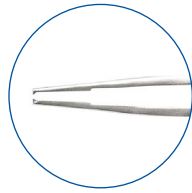

Tissue Forceps

1x2 Teeth, 0.12mm

S5-1385 Straight

Overall Length: 98mm

S5-1390 Curved

Overall Length: 97mm

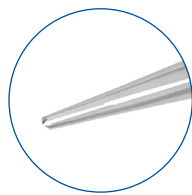

Graefe Fixation Forceps

S5-1400 4.5mm Jaws

Overall Length: 107mm

S5-1405 4.5mm Jaws, with Lock

Overall Length: 111mm

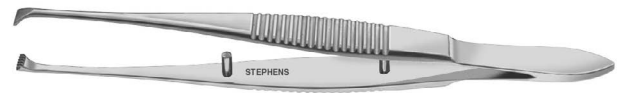
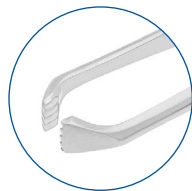

Moody Fixation Forceps

1x2 Teeth, 0.5mm, with Lock

S5-1410 Right

Overall Length: 105mm

S5-1415 Left

Overall Length: 105mm



Green Fixation Forceps

S5-1420 10mm Jaws, with Lock

Overall Length: 106mm

S5-1425 10mm Jaws, without Lock

Overall Length: 101mm

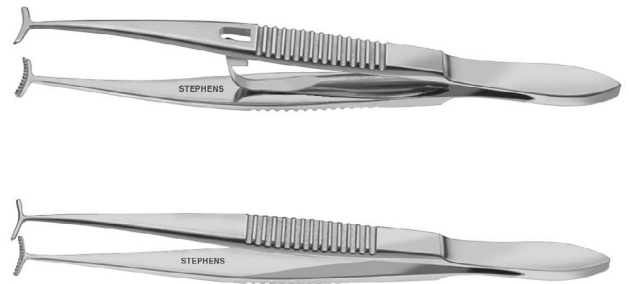

Kuhnt Fixation Forceps

S5-1430

Overall Length: 109mm

Guide Pin

1x2 Teeth, 0.5mm

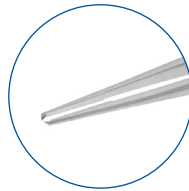

Lester Fixation Forceps

S5-1435 1x2 Teeth, 0.6mm

Overall Length: 98mm

S5-1440 2x3 Teeth, 0.6mm

Overall Length: 95mm

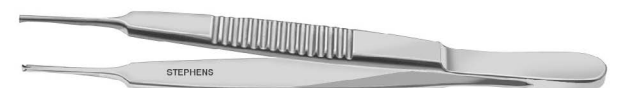
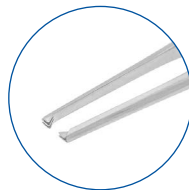
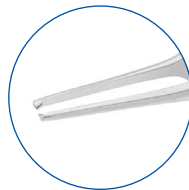

Hoffer-McPherson Corneal Bi-Fixation Forceps

S5-1443

Overall Length: 79mm

2 Sets of 1x2 Teeth, 0.12mm

Gills Handle

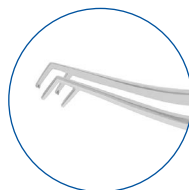

Hoffman-Polack Corneal Bi-Fixation Forceps

S5-1444

Overall Length: 105mm
2 sets of 1x2 Teeth, 0.12mm, 2mm Spread



Elschnig Fixation Forceps

S5-1445

Overall Length: 109mm
1x2 Teeth, 2.0mm

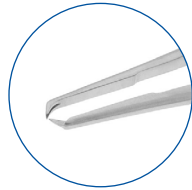

Thorpe Fixation Forceps

S5-1446

Overall Length: 95mm
2x3 Teeth, 0.12mm

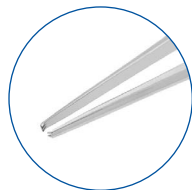

Stephens Bi-Fixation Forceps

2 sets of 1x2 Teeth, 0.12mm, 8mm Spread

S5-1447 with Lock

Overall Length: 110mm

S5-1447M Cross-Action

Overall Length: 108mm



Bores U-Shaped Fixation Forceps

2 sets of 1x2 Teeth, 0.12mm, 3mm Spread

S5-1449 Curved

Overall Length: 107mm

S5-1450 Straight

Overall Length: 104mm



Bracken Scleral-Fixation Forceps

S5-1451

Overall Length: 98mm
1x2 Teeth, 0.7mm

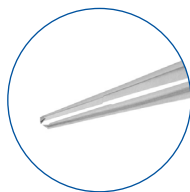

Stephens Bi-Fixation Forceps

2 sets of 1x2 Teeth, 0.12mm, 13mm Spread

S5-1453 Straight

Overall Length: 114mm

S5-1454 Angled

Overall Length: 110mm



Arruga Capsular Forceps

S5-1455

Overall Length: 102mm

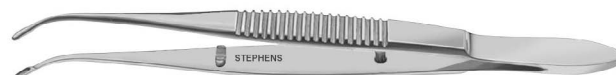
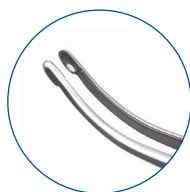

Castroviejo Capsular Forceps

S5-1470

Overall Length: 101mm

Cross-Action



Osher Superior Rectus Forceps

S5-1514

Overall Length: 98mm
1x2 Teeth, 0.5mm

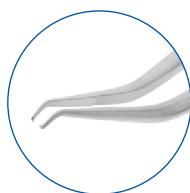

Troutman Superior Rectus Forceps**S5-1515**

Overall Length: 108mm

1x2 Teeth, 0.5mm

Angled

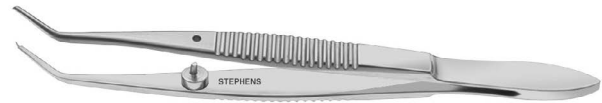
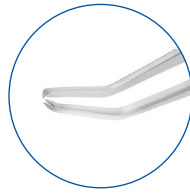
**Dastoor Superior Rectus Forceps****S5-1516**

Overall Length: 101mm

1x2 Teeth, 0.5mm

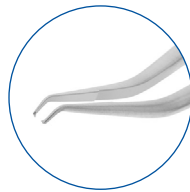
**Buratto LASIK Flap Forceps****S5-1520**

Overall Length: 110mm

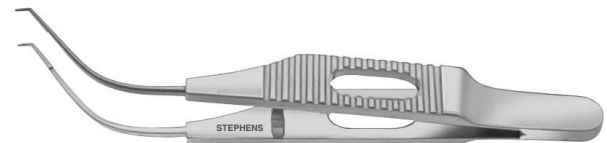
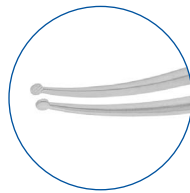
**Mendez LASIK Flap Forceps****S5-1525**

Overall Length: 111mm

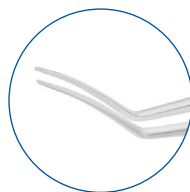
**Scleral Plug Forceps****S5-1530**

Overall Length: 105mm



Femto LRI Enhancement Forceps

S5-1535

Overall Length: 109mm

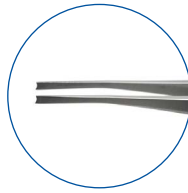

Bock Suture Forceps

S5-1550

Overall Length: 100mm

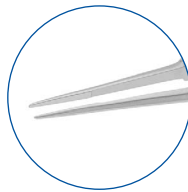

Suture Forceps

S5-1555

Overall Length: 98mm
Tying Platform, Curved
Round Handle

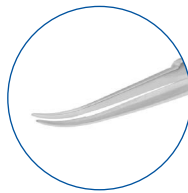

Castroviejo Suturing Forceps

Tying Platform

S5-1560 1x2 Teeth, 0.12mm, Overall Length: 105mm

S5-1565 1x2 Teeth, 0.2mm, Overall Length: 111mm

S5-1570 1x2 Teeth, 0.3mm, Overall Length: 106mm

S5-1575 1x2 Teeth, 0.5mm, Overall Length: 106mm

S5-1580 1x2 Teeth, 0.9mm, Overall Length: 113mm

S5-1585 1x2 Teeth, 1.5mm, Overall Length: 110mm

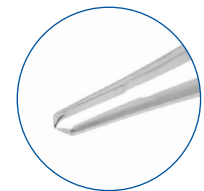
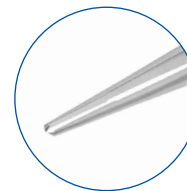
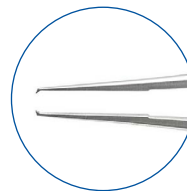

Castroviejo Suturing Forceps

Tying Platform, With Lock

S5-1561 1x2 Teeth, 0.12mm, Overall Length: 112mm

S5-1571 1x2 Teeth, 0.3mm, Overall Length: 107mm

S5-1576 1x2 Teeth, 0.5mm, Overall Length: 109mm

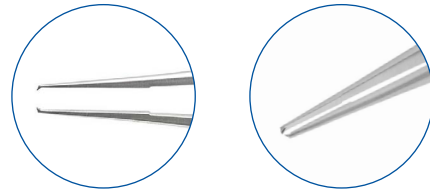
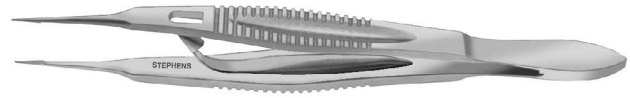

Castroviejo Suturing Forceps

Tying Platform, Angled

S5-1590 1x2 Teeth, 0.3mm

Overall Length: 106mm

S5-1595 1x2 Teeth, 0.5mm

Overall Length: 107mm

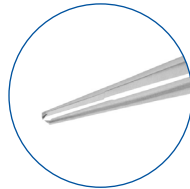

Castroviejo-Snyder Forceps

S5-1600

Overall Length: 110mm

1x2 Teeth, 0.12mm

Tying Platform

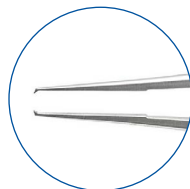

Utrata Capsulorhexis Forceps

S5-1601

Overall Length: 104mm

Round Handle

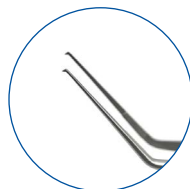

Masket Capsulorhexis Forceps

S5-1602

Overall Length: 105mm
Flat Handle

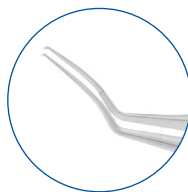

Utrata Capsulorhexis Forceps

S5-1603

Overall Length: 105mm
Flat Handle

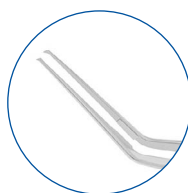

Kraf Capsule Tag Forceps

S5-1604

Overall Length: 107mm
11mm Jaws, Angled
Tying Platform

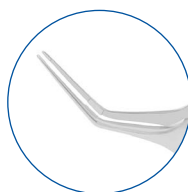

Gaskin Fragment Forceps

11mm Jaws, Angled

S5-1605 11mm Tying Platform

Overall Length: 105mm

S5-1606 5mm Tying Platform

Overall Length: 105mm

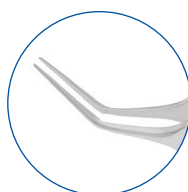

Stephens Capsulotomy Forceps

S5-1607

Overall Length: 119mm
8mm Jaws



Kansas Nucleus Fragment Forceps

S5-1608

Overall Length: 105mm



Harms Tying Forceps

Tying Platform, Smooth Jaws

S5-1610 Straight

Overall Length: 110mm

S5-1615 Curved

Overall Length: 114mm

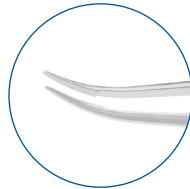
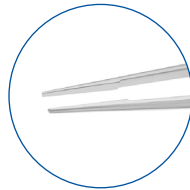

Inamura Capsulorhexis Forceps

S5-1611

Overall Length: 105mm

Cross-Action



MICS Capsulorhexis Forceps

S5-1613

Overall Length: 104mm

With Guide Marks

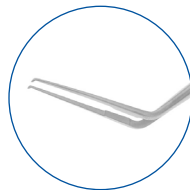

Jaffe Tying Forceps

Tying Platform, Smooth Jaws

S5-1620 Straight
Overall Length: 110mm

S5-1625 Curved
Overall Length: 110mm

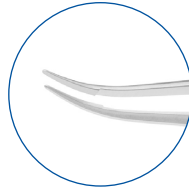
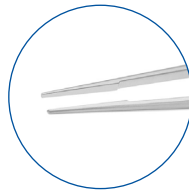

Kelman-McPherson Tying Forceps

8mm Jaws, Angled

S5-1630 Long Handle
Overall Length: 106mm

S5-1632 Short Handle
Overall Length: 81mm

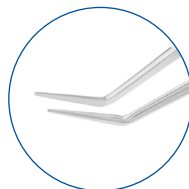

Bonn Tying Forceps

S5-1635
Overall Length: 98mm
1x2 Teeth, 0.12mm
Tying Platform

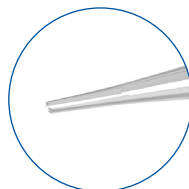

McPherson Tying Forceps

Smooth Jaw

S5-1640 Straight
Overall Length: 86mm

S5-1645 Angled
Overall Length: 85mm

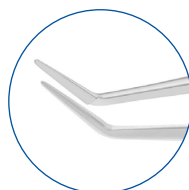
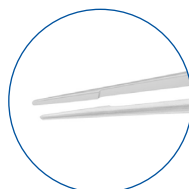

McPherson Tying Forceps

1x2 Teeth, 0.12mm

S5-1643 Straight

Overall Length: 84mm

S5-1647 Angled

Overall Length: 79mm

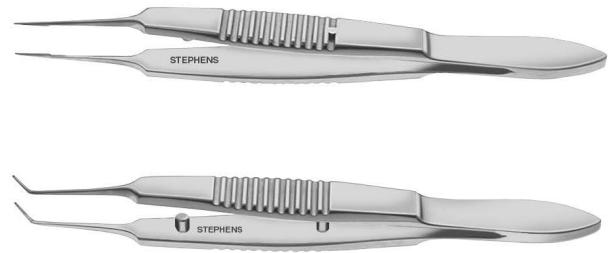
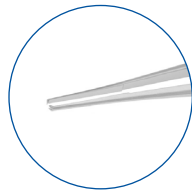

McPherson Tying Forceps

Tying Platform, Long Handle

S5-1650 Straight

Overall Length: 111mm

S5-1655 Angled

Overall Length: 107mm

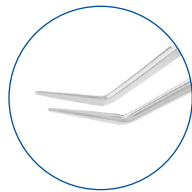
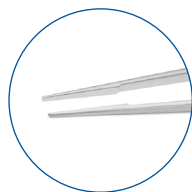

DMEK Tissue Prep Forceps

S5-1655M

Overall Length: 101mm

2.5mm Platform



Shepard Tying Forceps

6mm Platform

S5-1656 Straight

Overall Length: 111mm

S5-1657 Angled

Overall Length: 100mm

S5-1658 Curved

Overall Length: 110mm

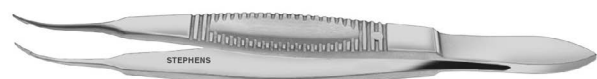

Sinskey Tying Forceps

S5-1660

Overall Length: 106mm
Smooth Jaws
Straight

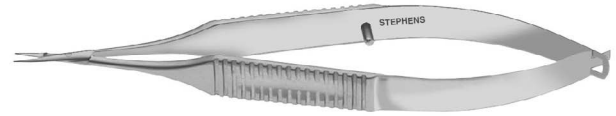

Sauer Suture Forceps

S5-1666

Overall Length: 87mm
1x2 Teeth, 0.5mm
Oblique Angle

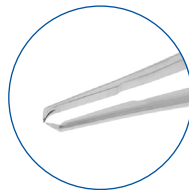

Paufique Suture Forceps

S5-1667

Overall Length: 83mm
1x2 Teeth, 0.3mm
Tying Platform

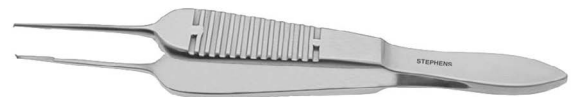
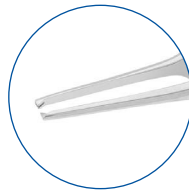

Manhattan Eye & Ear Forceps

S5-1668

Overall Length: 87mm
1x2 Teeth, 0.5mm

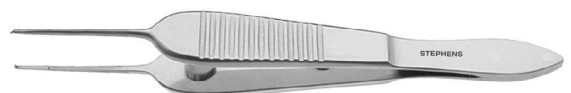
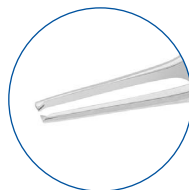

Tennant Tying Forceps

Tying Platform

S5-1670

Straight

Overall Length: 103mm

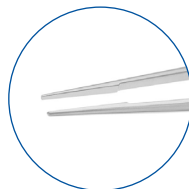

S5-1675

Curved

Overall Length: 103mm

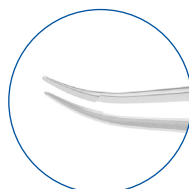

Stephens Tying Forceps

Tying Platform

S5-1676 Straight

Overall Length: 104mm

S5-1677 Curved

Overall Length: 99mm



Lieberman-Tennant Tying Forceps

Guide Pin

S5-1678 Straight

Overall Length: 105mm

S5-1679 Curved

Overall Length: 105mm

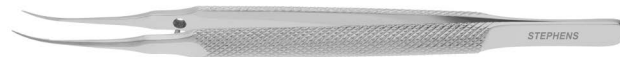
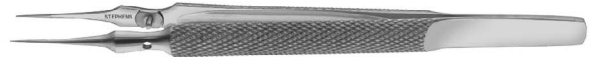

Paton Tying Forceps

S5-1680

Overall Length: 104mm

Tying Platform, Sharp Point



Jewelers Forceps

S5-1690

Overall Length: 120mm

#1, Straight



Jewelers Forceps

S5-1695

Overall Length: 120mm

#3, Straight



Jewelers Forceps

S5-1695T

Overall Length: 118mm
 #3 Straight
 Tying Platform

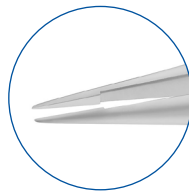

Jewelers Forceps

S5-1700

Overall Length: 111mm
 #3C, Straight
 Short Taper



Jewelers Forceps

S5-1705

Overall Length: 113mm
 #4, Straight



Jewelers Forceps

S5-1710

Overall Length: 113mm
 #5, Straight



Jewelers Forceps

S5-1715

Overall Length: 113mm
 #5A, Angled



Jewelers Forceps

S5-1720

Overall Length: 115mm
 #7, Curved



Binkhorst Lens Forceps

S5-1735

Overall Length: 115mm



Blaydes Lens Forceps

S5-1741

Overall Length: 111mm



Kelman Lens Holding & Manipulating Forceps

S5-1742

Overall Length: 118mm



Stephens Lens Folding Forceps

S5-1793

Overall Length: 105mm



Livernois Lens Forceps

S5-1794M

Overall Length: 108mm



Cross-Action Lens Folding Forceps

S5-1798

Overall Length: 106mm



Stephens Lens Insertion Forceps

S5-1799

Overall Length: 115mm



Shepard Lens Holding Forceps

S5-1800

Overall Length: 118mm



Stephens Soft IOL Insertion Forceps

S5-1802

Overall Length: 107mm



Humer Lens Folding Forceps

S5-1804

Overall Length: 110mm



Shepard Lens Forceps

S5-1805 with Lock

Overall Length: 118mm



S5-1820 with Notches on jaw

Overall Length: 112mm



Artisan Lens Implantation Forceps

S5-1815

Overall Length: 121mm



Dimarco Lens Folding-Insertion Forceps

S5-1836

Overall Length: 135mm



Sattler Muscle Forceps

with Lock

S5-1840 Left

Overall Length: 98mm

S5-1845 Right

Overall Length: 98mm



Jameson Muscle Forceps

with Lock

S5-1850 Child, Right

Overall Length: 98mm

S5-1855 Child, Left

Overall Length: 98mm

S5-1860 Adult, Left

Overall Length: 99mm

S5-1865 Adult, Right

Overall Length: 99mm



Swiss Model Muscle Forceps

S5-1870 Left

Overall Length: 112mm

S5-1875 Right

Overall Length: 112mm

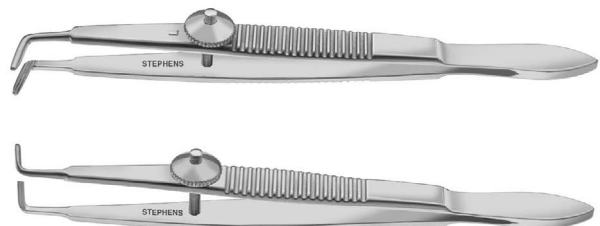

Gunderson Muscle Forceps

S5-1880

Overall Length: 114mm



Putterman Muscle Conjunctival Clamp

S5-1885

Overall Length: 94mm



Foreign Body Forceps

S5-1890

Overall Length: 86mm



Bonaccolto Utility & Splinter Forceps

S5-1895

Overall Length: 110mm

Serrated

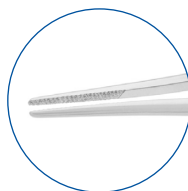

Bores Incision Spreading Forceps

S5-1900

Overall Length: 107mm

Serrated Jaws

0.5mm



Dodick Nucleus Cracker

S5-1901

Overall Length: 109mm

Long Handle



Stephens Phaco Pre-Splitter

S5-1903

Overall Length: 120mm

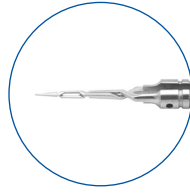

Akahoshi Pre-Chop

S5-1903A Angled Jaws

Overall Length: 120mm

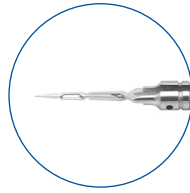

S5-1903C Combo Jaws

Overall Length: 120mm

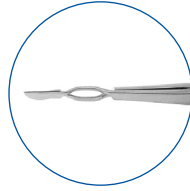

S5-1903P Paddle Jaws

Overall Length: 120mm

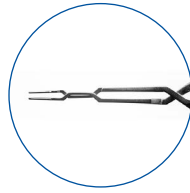

Baby Jones Towel Clamp

S5-1904

Overall Length: 56mm



Backhaus Towel Clamp

S5-1904A

Overall Length: 108mm



Mosquito Hemostat



S5-1905 Short Model, Straight
Overall Length: 90mm



S5-1910 Short Model, Curved
Overall Length: 90mm



S5-1915 Long Model, Straight
Overall Length: 145mm

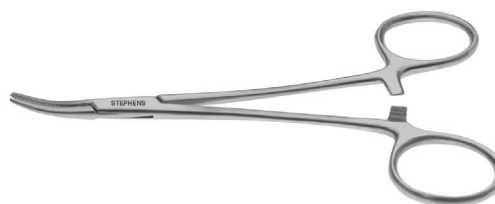

S5-1920 Long Model, Curved
Overall Length: 126mm

Diffenbach Serrefine

S5-1925 Straight
Overall Length: 37mm



S5-1930 Curved
Overall Length: 38mm



Utility Forceps

Straight

S5-1935 Serrated
Overall Length: 100mm

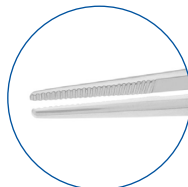

S5-1940 1x2 Teeth, 0.5mm
Overall Length: 102mm

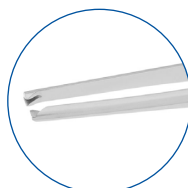

Mccullough Utility Forceps

S5-1945 Serrated

Overall Length: 93mm

S5-1950 1x2 Teeth, 0.7mm

Overall Length: 94.5mm

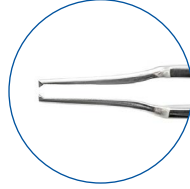
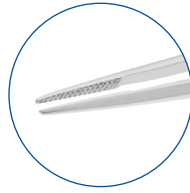

Wills Hospital Utility Forceps

S5-1955

Overall Length: 101mm

Serrated

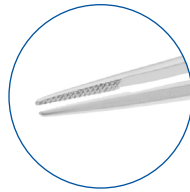

Bonaccolto Utility Forceps

S5-1960 Delicate Model

Overall Length: 106mm

S5-1965 Heavy Model

Overall Length: 105mm



Beyer Rongeur Forceps

S5-1980

Overall Length: 140mm



Citelli Rongeur Forceps

S5-1985

Overall Length: 146mm



Kerrison Rongeur Forceps



S5-1990 #1

Overall Length: 170mm

3.5mm Punch



S5-1995 #2

Overall Length: 165mm

4.0mm Punch



S5-2000 #3

Overall Length: 185mm

4.5mm Punch

Pierse Tissue Fixation Forceps

S5-2005

Overall Length: 95mm



Pierse Corneal Forceps

S5-2020

Overall Length: 84mm

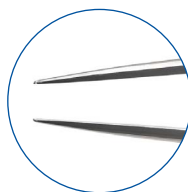

Pierse Forceps

S5-2025

Overall Length: 88mm

Fine Jaws for Microscopic Use

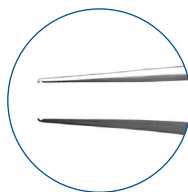

Pierse Tissue Fixation Forceps

S5-2030

Overall Length: 81mm



Pierse Tying Forceps

S5-2055

Overall Length: 86mm
Elongated Tip

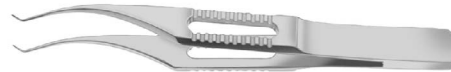
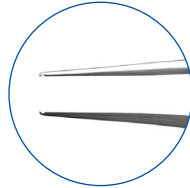

Barraquer Needle Holder

Standard Jaws, Curved

S6-1000 without Lock

Overall Length: 136mm

S6-1005 with Lock

Overall Length: 136mm

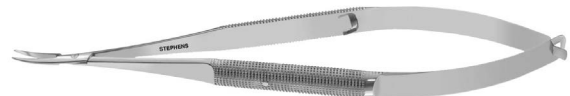

Barraquer Needle Holder

Heavy Jaws

S6-1006 Straight, with Lock

Overall Length: 135mm

S6-1007 Straight, without Lock

Overall Length: 137mm

S6-1008 Curved, with Lock

Overall Length: 130mm

S6-1009 Curved, without Lock

Overall Length: 135mm

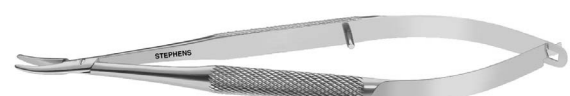

Barraquer Needle Holder

0.5mm Jaws, Curved

S6-1010 without Lock

Overall Length: 145mm

S6-1015 with Lock

Overall Length: 141mm



Barraquer Needle Holder

0.75mm Jaws, Curved

S6-1020 without Lock

Overall Length: 143mm

S6-1025 with Lock

Overall Length: 146mm



Barraquer Short Needle Holder

Delicate Jaws

S6-1030 Straight, without Lock

Overall Length: 94mm

S6-1035 Straight, with Lock

Overall Length: 96mm

S6-1040 Curved, without Lock

Overall Length: 93mm

S6-1045 Curved, with Lock

Overall Length: 95mm

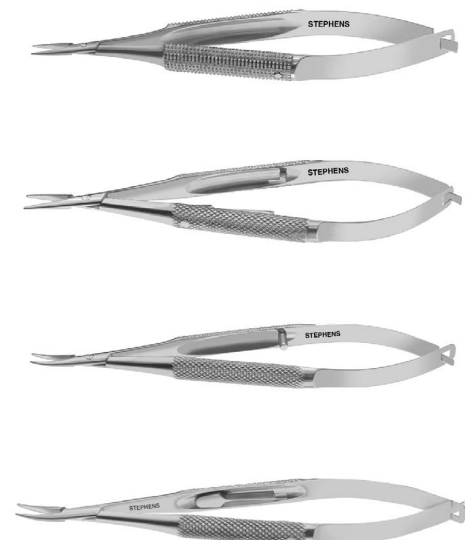

Castroviejo Needle Holder

Standard Jaws

S6-1050 Straight, with Lock

Overall Length: 142mm

S6-1051 Straight, without Lock

Overall Length: 138mm

S6-1052 Curved, without Lock

Overall Length: 138mm

S6-1055 Curved, with Lock

Overall Length: 144mm

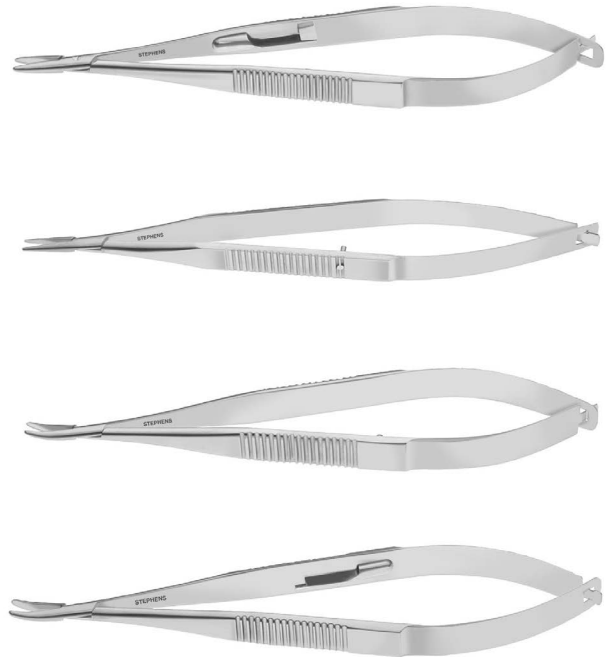

Castroviejo Needle Holder

Delicate Jaws

S6-1060 Straight, without Lock

Overall Length: 136mm

S6-1065 Straight, with Lock

Overall Length: 142mm

S6-1070 Curved, without Lock

Overall Length: 137mm

S6-1075 Curved, with Lock

Overall Length: 140mm

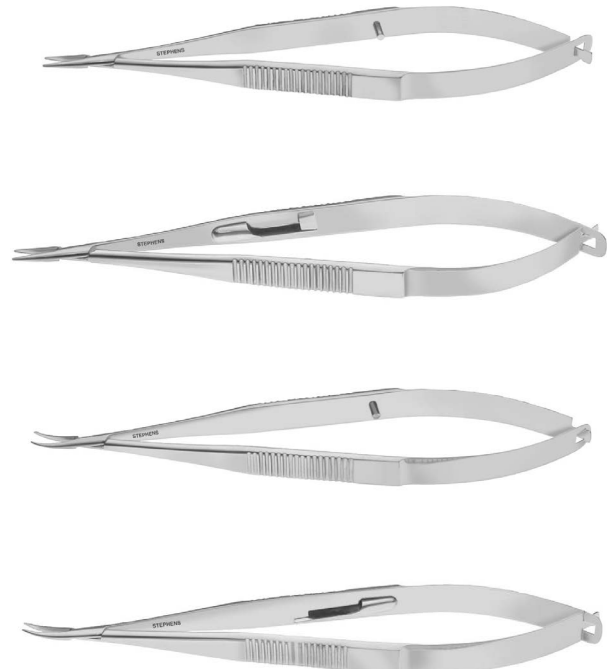

Castroviejo Needle Holder

Delicate Conical Jaws

S6-1076 Straight, without Lock

Overall Length: 131mm

S6-1077 Straight, with Lock

Overall Length: 132mm

S6-1078 Curved, without Lock

Overall Length: 129mm

S6-1079 Curved, with Lock

Overall Length: 136mm

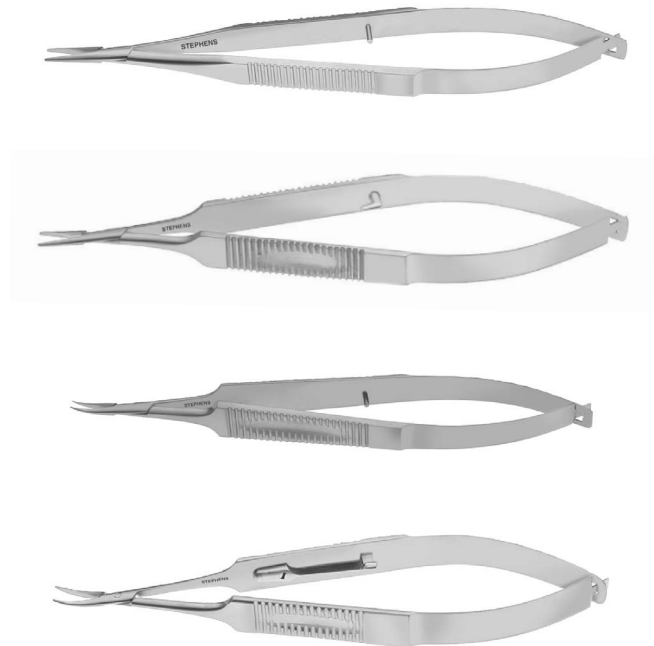

Castroviejo Needle Holder

Round Handle, Standard Conical Jaws

S6-1080 Straight, without Lock

Overall Length: 125mm

S6-1085 Straight, with Lock

Overall Length: 126mm



Jaffe Needle Holder

Delicate Conical Jaws

S6-1090 Straight, without Lock

Overall Length: 138mm

S6-1095 Straight, with Lock

Overall Length: 133mm



Jaffe Needle Holder

Delicate Jaws

S6-1100 Curved, without Lock

Overall Length: 134mm

S6-1105 Curved, with Lock

Overall Length: 136mm



Kalt Needle Holder

S6-1110 Straight

Overall Length: 138mm

S6-1111 Curved

Overall Length: 137mm

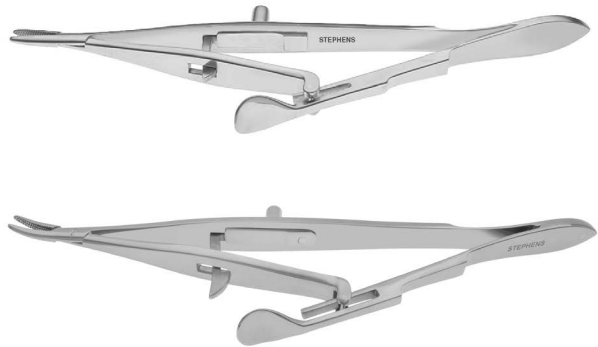

Stephens Needle Holder

Delicate Jaws

S6-1115 Straight, without Lock

Overall Length: 127mm

S6-1120 Straight, with Lock

Overall Length: 125mm

S6-1125 Curved, without Lock

Overall Length: 123mm

S6-1130 Curved, with Lock

Overall Length: 120mm

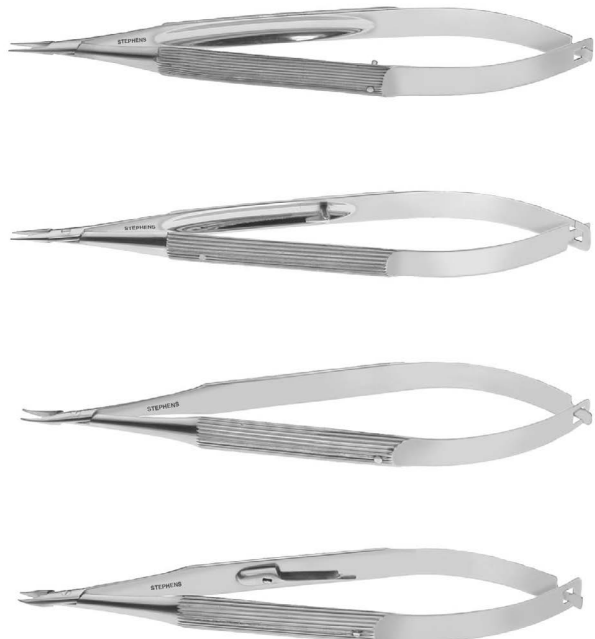

McPherson Needle Holder

Delicate Jaws

S6-1140 Straight, without Lock

Overall Length: 108mm

S6-1145 Straight, with Lock

Overall Length: 111mm

S6-1150 Curved, without Lock

Overall Length: 112mm

S6-1155 Curved, with Lock

Overall Length: 111mm

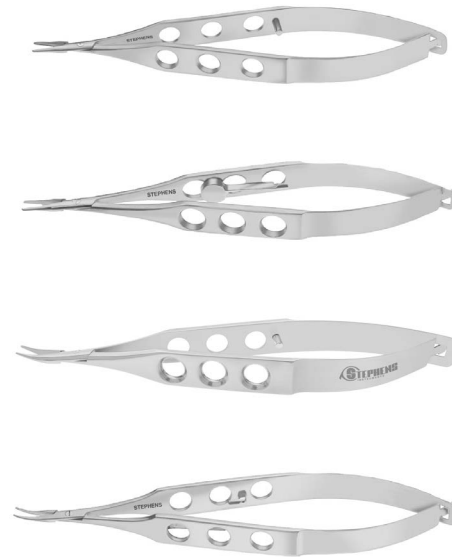

Micro Needle Holder

S6-1170 Curved, without Lock

Overall Length: 105mm

S6-1175 Curved, with Lock

Overall Length: 100mm



Barraquer-Troutman Needle Holder

Curved

S6-1185 without Lock

Overall Length: 96mm

S6-1190 with Lock

Overall Length: 99mm



Barraquer-Troutman Needle Holder

Micro Jaws, 0.5mm, Curved

S6-1205 without Lock

Overall Length: 134mm

S6-1210 with Lock

Overall Length: 126mm



Troutman Needle Holder

Delicate Jaws, Strong Curve

S6-1215 without Lock

Overall Length: 122mm

S6-1220 with Lock

Overall Length: 120mm



Iris Scissors

Short Model

S7-1000 Straight

Overall Length: 92mm

S7-1005 Curved

Overall Length: 90mm



Iris Scissors

S7-1010

Overall Length: 97mm

Angled



Iris Scissors

Long Model

S7-1015 Straight

Overall Length: 110mm

S7-1020 Curved

Overall Length: 109mm



Iris Scissors

S7-1030

Overall Length: 107mm

Ribbon Type

Curved



Large Ring Scissors

S7-1035 Straight

Overall Length: 109mm

S7-1040 Curved

Overall Length: 112mm



Needle Point Stitch Scissors

S7-1045 Straight

Overall Length: 100mm

S7-1050 Curved

Overall Length: 105mm



Knapp Strabismus Scissors

S7-1055 Straight

Overall Length: 107mm

S7-1060 Curved

Overall Length: 106mm



Strabismus Scissors

S7-1065

Overall Length: 108mm

Straight, with Probe Points



Maunoir Iris Scissors

S7-1070

Overall Length: 107mm



Aebli Angular Scissors

S7-1075 Right

Overall Length: 101mm

S7-1080 Left

Overall Length: 96mm



Stevens Tenotomy Scissors

S7-1085 Straight

Overall Length: 115mm

S7-1090 Curved

Overall Length: 115mm

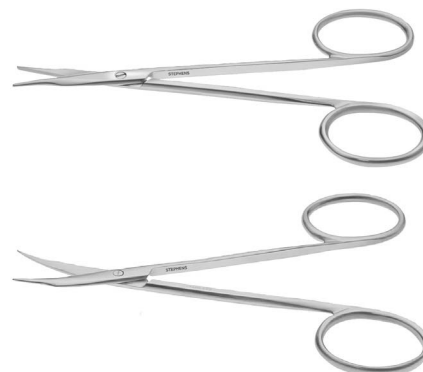

Stevens Tenotomy Scissors

Ribbon Type

S7-1095 Straight

Overall Length: 101mm

S7-1100 Curved

Overall Length: 100mm



Mayo Scissors

S7-1098

Overall Length: 142mm

Straight



Knapp Strabismus Scissors

S7-1110 Straight

Overall Length: 120mm

S7-1115 Curved

Overall Length: 121mm

S7-1117 Strong Curve

Overall Length: 119mm

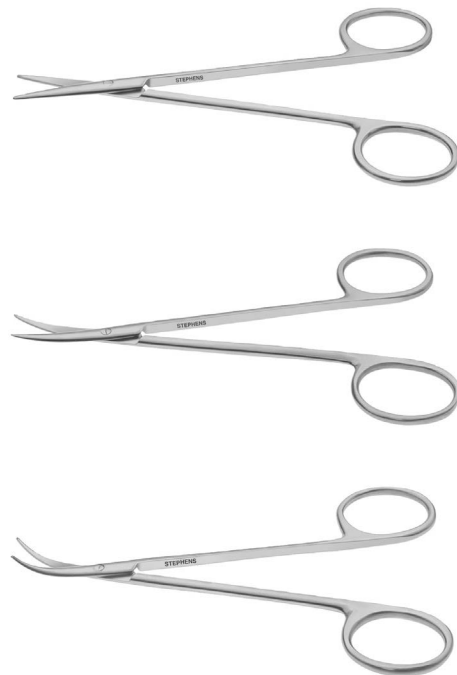

Knapp Strabismus Scissors

Ribbon Type

S7-1120 Straight

Overall Length: 108mm

S7-1125 Curved

Overall Length: 111mm



Enucleation Scissors

S7-1130 Medium Curve

Overall Length: 136mm

S7-1135 Strong Curve

Overall Length: 132mm

S7-1137 Light Curve

Overall Length: 134mm



Stephens DALK Scissors

S7-1150

Overall Length: 102mm



Castroviejo Corneal Section Scissors

S7-1165 Small Blades, Right

Overall Length: 108mm

S7-1170 Small Blades, Left

Overall Length: 107mm

S7-1175 Medium Blades, Right

Overall Length: 109mm

S7-1180 Medium Blades, Left

Overall Length: 110mm

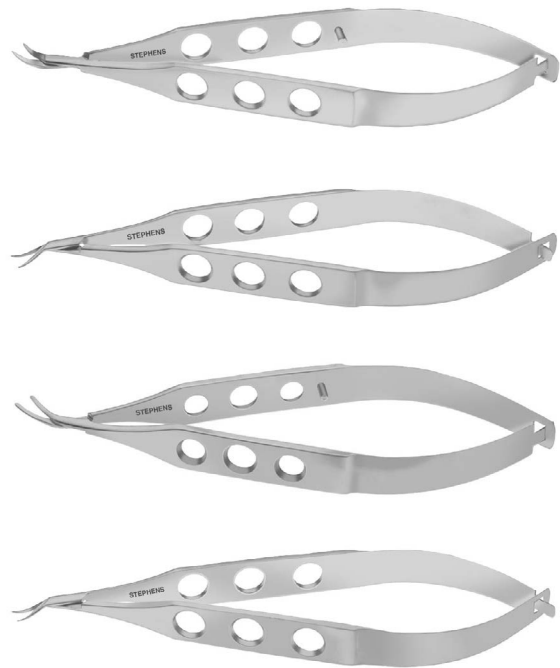

Troutman-Castroviejo Scissors

Small Blades

S7-1185 Right

Overall Length: 108mm

S7-1190 Left

Overall Length: 110mm



Troutman-Castroviejo Corneal Scissors

Medium Blades, with Lock

S7-1195 Right

Overall Length: 108mm

S7-1200 Left

Overall Length: 109mm



Miniature Corneal Scissors

S7-1205

Overall Length: 98mm
Blunt, Angles



Miniature Corneal Scissors

S7-1210

Overall Length: 96mm
Blunt, Curved



Mcguire Corneal Scissors

S7-1211 Right

Overall Length: 108mm

S7-1212 Left

Overall Length: 112mm



Castroviejo Corneal Scissors

S7-1233

Overall Length: 112mm
Large Blades, Curved, Blunt Tip
Wide Handle



Castroviejo Corneal Scissors

Large Blades, Curved, Blunt Tip

S7-1234 Wide Handle

Overall Length: 132mm

S7-1235 Standard Handle

Overall Length: 115mm

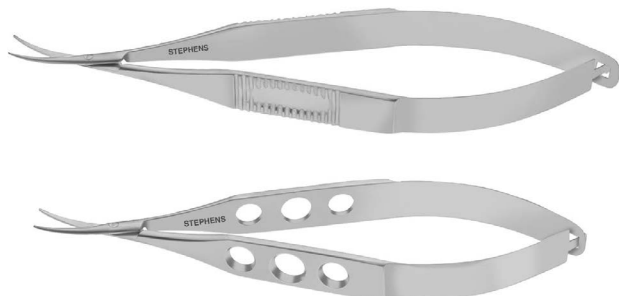

Azar Corneal Scissors

S7-1235A

Overall Length: 112mm
Marked for Incision Measurement
1mm - 6mm



Castroviejo Corneal Scissors

S7-1240

Overall Length: 117mm
Medium Blades
Curved, Blunt

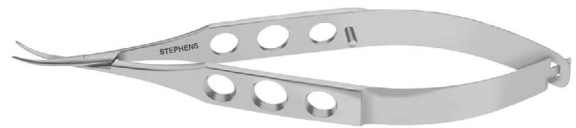

Castroviejo Corneal Section Scissors

S7-1245

Overall Length: 106mm
Small Blades
Curved, Blunt



Castroviejo Universal Scissors

S7-1246

Overall Length: 93mm
Small Blades



Castroviejo Corneal Scissors

S7-1250

Overall Length: 116mm
Strong Curve



Shepard-Castro Corneal Scissors

S7-1255

Overall Length: 115mm
One Serrated Blade
Curved, Blunt



Katzin Miniature Scissors

S7-1260 Right

Overall Length: 102mm

S7-1265 Left

Overall Length: 100mm

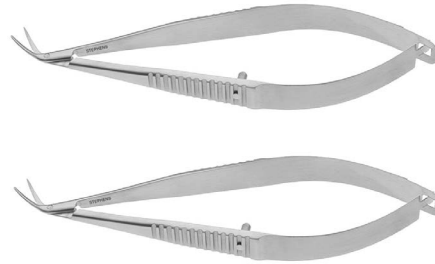

Troutman Miniature Corneal Section Scissors

S7-1270 Right

Overall Length: 95mm

S7-1275 Left

Overall Length: 93mm

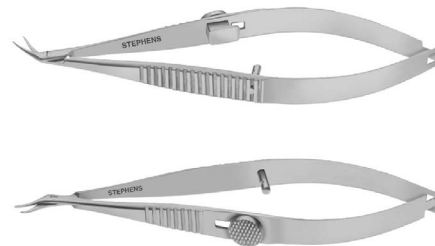

Lund Micro Keratoplasty Scissors

S7-1280 Right

Overall Length: 100mm

S7-1285 Left

Overall Length: 98mm



Castroviejo Keratoplasty Scissors

S7-1295

Overall Length: 109mm

Blunt, Angled

Medium Blades



McPherson-Westcott Conjunctiva Scissors

S7-1305

Overall Length: 106mm

Small Blades

Curved, Blunt



Westcott-Barraquer Scissors

S7-1310 Sharp

Overall Length: 112mm

S7-1311 Blunt

Overall Length: 109mm



Westcott Tenotomy Scissors

S7-1314

Overall Length: 111mm

Straight



Westcott Tenotomy Stitch Scissors

S7-1315

Overall Length: 105mm

Straight

Extra Sharp



Westcott Tenotomy Scissors

Standard Blades

S7-1320 Sharp

Overall Length: 115mm

S7-1325 Blunt

Overall Length: 115mm



Westcott Tenotomy Scissors

S7-1321

Overall Length: 97mm

Short Model



Stephens-Westcott Conjunctiva Scissors

S7-1326

Overall Length: 129mm
Curved



McPherson-Westcott Stitch Scissors

S7-1330

Overall Length: 105mm
Small Blades
Extra Sharp



Jaffe Stitch Scissors

Delicate, Sharp Tip

S7-1335 Long Model

Overall Length: 135mm

S7-1336 Short Model

Overall Length: 114mm

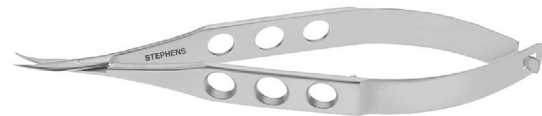

Iris Miniature Scissors

S7-1340 Sharp Tips, Straight

Overall Length: 100mm

S7-1345 Sharp Tips, Curved

Overall Length: 94mm



Barraquer Iris Scissors

S7-1360 7mm Blades

Overall Length: 57mm

S7-1365 10mm Blades

Overall Length: 59mm



Stephens Scissors

S7-1364

Overall Length: 112mm



Stephens-Vannas Scissors

7mm Blades

S7-1366 Straight

Overall Length: 105mm

S7-1367 Curved

Overall Length: 105mm



Stephens-Gills Scissors

11mm Blades

S7-1368 Straight

Overall Length: 109mm

S7-1369 Curved

Overall Length: 107mm



Vannas Capsulotomy Scissors

S7-1370 Straight

Overall Length: 82mm

S7-1375 Curved

Overall Length: 84mm



Vannas Capsulotomy Scissors

S7-1380

Overall Length: 80mm

Angled



Stern-Gills Vannas Scissors

S7-1384

Overall Length: 111mm
11mm Blades



Vannas Capsulotomy Scissors

S7-1385

Overall Length: 82mm
Ribbon Type
Angled Forward



Gills Vannas Scissors

11mm Blade, Delicate

S7-1386 Angled

Overall Length: 89mm

S7-1387 Straight

Overall Length: 87mm

S7-1388 Curved

Overall Length: 86mm



Cohan-Vannas Scissors

S7-1389

Overall Length: 62mm
Delicate Blades
Sharp



Harms Trabeculotomy Probe

S8-1000 Right

Overall Length: 47mm

S8-1005 Left

Overall Length: 47mm



Lacrimal Dilator

S8-1010

Overall Length: 75mm

Infant



Castroviejo Lacrimal Dilator

S8-1015

Overall Length: 137mm

Medium & Fine Tips



Muldon Lacrimal Dilator

S8-1020

Overall Length: 110mm

Graduated Tip



Simpson Lacrimal Dilator

S8-1025 #1, Medium

Overall Length: 106mm

S8-1030 #2, Fine

Overall Length: 110mm



Wilder Lacrimal Dilator

S8-1035 Heavy Taper

Overall Length: 100mm

S8-1040 Medium Taper

Overall Length: 101mm

S8-1045 Fine Taper

Overall Length: 101mm



Naugle-Fleming Knurled Dilator

S8-1035M

Overall Length: 100mm
3.5mm Diameter, CDCR



Ziegler Lacrimal Canal Probe

S8-1050

Overall Length: 122mm



Rolf Lacrimal Sac Probe

S8-1055

Overall Length: 148mm



Pigtail Probe With Suture Holes

S8-1060

Overall Length: 155mm



Bowman Lacrimal Probe

Sterling Silver

S8-1065 4/0 - 3/0

Overall Length: 153mm



S8-1070 00 - 0

Overall Length: 153mm



S8-1075 1 - 2

Overall Length: 153mm



S8-1080 3 - 4

Overall Length: 152mm



S8-1085 5 - 6

Overall Length: 153mm



S8-1090 7 - 8

Overall Length: 155mm



Williams Lacrimal Bulbous Probe

Sterling Silver

S8-1095 00 - 0

Overall Length: 153mm

S8-1100 1 - 2

Overall Length: 153mm

S8-1105 3 - 4

Overall Length: 153mm

S8-1110 5 - 6

Overall Length: 153mm

S8-1115 7 - 8

Overall Length: 146mm

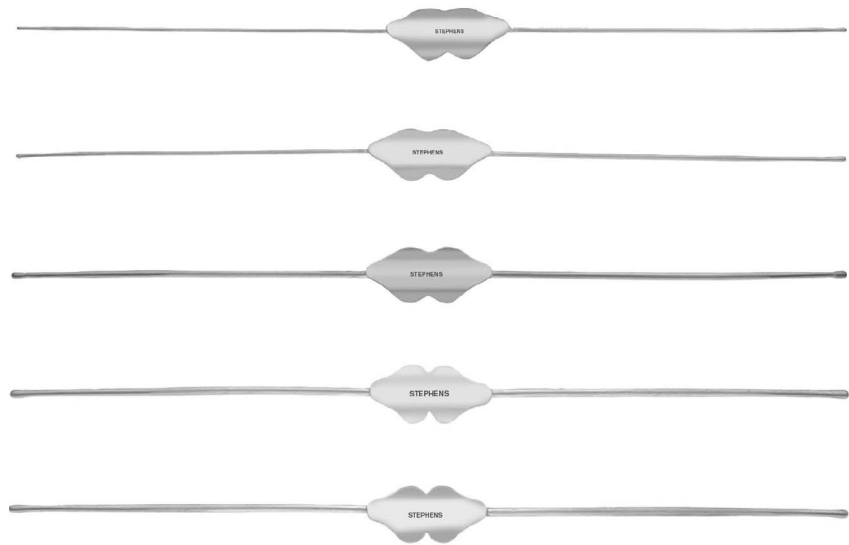

VeraPlug Punctal Sizer

S8-1200 (Small/Medium) 0.5 - 0.6

Overall Length: 91mm

S8-1205 (Large/Extra Large) 0.7 - 0.8

Overall Length: 91mm

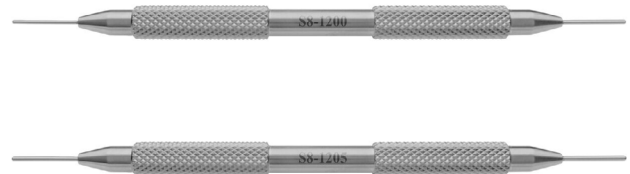

Punctal Gauge Set with Sterilization Tray

S8-1210

0.5–0.6, 0.7–0.8

Tray Size: 2.5" x 6" x 0.75"

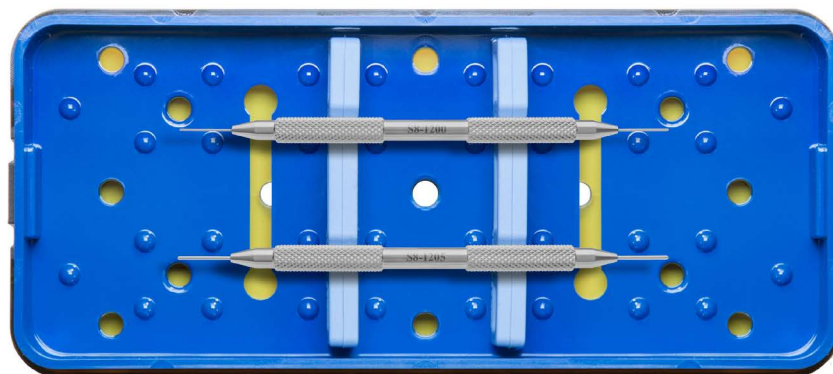

Shepard-Hoffer Optic Zone Marker with Cross Hairs

S9-1000 3.0mm

Overall Length: 102mm

S9-1001 2.75mm

Overall Length: 83mm

S9-1005 3.25mm

Overall Length: 110mm

S9-1010 3.50mm

Overall Length: 100mm

S9-1015 3.75mm

Overall Length: 80mm

S9-1020 4.0mm

Overall Length: 109mm

S9-1025 4.25mm

Overall Length: 84mm

S9-1030 4.5mm

Overall Length: 83mm

S9-1035 4.75mm

Overall Length: 101mm

S9-1040 5.0mm

Overall Length: 106mm

S9-1041 5.5mm

Overall Length: 99mm

S9-1045 6.0mm

Overall Length: 106mm

S9-1050 6.5mm

Overall Length: 86mm

S9-1055 7.0mm

Overall Length: 113mm

S9-1060 7.5mm

Overall Length: 113mm

S9-1064 8.0mm

Overall Length: 129mm

S9-1065 9.0mm

Overall Length: 116mm



Mendez Axis Finder

S9-1068

Overall Length: 112mm



4 Line Astigmatism Marker

S9-1108

Overall Length: 112mm



Radial Marker

90 Degree

S9-1109 4 Incisions

Overall Length: 111mm

S9-1110 6 Incisions

Overall Length: 108mm

S9-1115 8 Incisions

Overall Length: 107mm

S9-1116 10 Incisions

Overall Length: 110mm

S9-1120 12 Incisions

Overall Length: 109mm

S9-1125 16 Incisions

Overall Length: 112mm

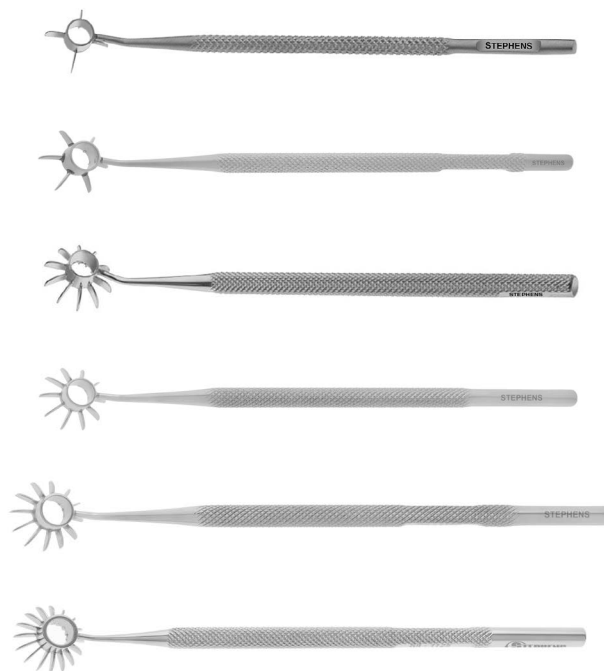

Thornton Low Profile Marker

Gunpoint

S9-1251 3.0mm

Overall Length: 79mm

S9-1252 3.25mm

Overall Length: 83mm

S9-1253 3.5mm

Overall Length: 81mm

S9-1254 3.75mm

Overall Length: 99mm

S9-1255 4.0mm

Overall Length: 84mm

S9-1260 4.25mm

Overall Length: 84mm

S9-1261 4.5mm

Overall Length: 85mm

S9-1262 4.75mm

Overall Length: 84mm

S9-1263 5.0mm

Overall Length: 85mm

S9-1263A 5.5mm

Overall Length: 90mm

S9-1264 6.0mm

Overall Length: 85mm

S9-1265 7.0mm

Overall Length: 84mm

S9-1266 8.0mm

Overall Length: 99mm



Pettigrove PRK Marker/Spatula**S9-1408** 6.5mm

Overall Length: 103mm

S9-1409 7.0mm

Overall Length: 100mm

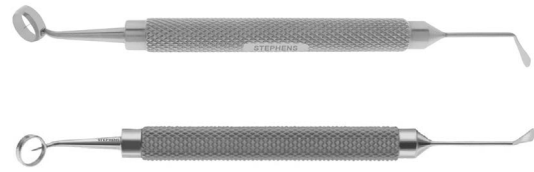
**LASEK Alcohol Well****S9-1535** 8.5mm

Overall Length: 132mm

S9-1536 9.5mm

Overall Length: 132mm

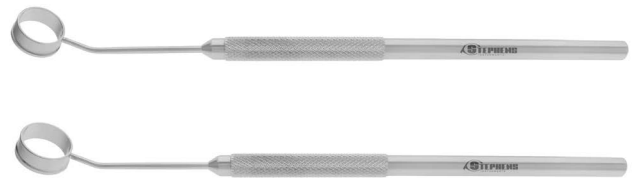
**Bores Axis Marker****S9-1570**

Overall Length: 102mm

**Berkeley Double Marker****S9-1602**

Overall Length: 126mm

3.5mm & 3.75mm

**F Marker Flat****S9-1800**

Overall Length: 114mm

**F Marker 45deg****S9-1805**

Overall Length: 114mm

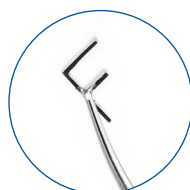

S Marker Flat**S9-1900**

Overall Length: 114mm

**S Marker 45deg****S9-1905**

Overall Length: 114mm

**Henderson Pre-Operative Alignment Marker****S9-2033**

Overall Length: 103mm

**LRI Gravity Marker****S9-2040**

Overall Length: 154mm

12.5mm Spread

Marker at 3 and 9

**Henderson LRI Axis Marker****S9-2050**

Overall Length: 101mm

30, 45, 60 Degree

**Henderson Degree Gauge****S9-2060**

Overall Length: 107mm



Henderson Toric IOL Marker

S9-2065

Overall Length: 100mm



Stephens Toric IOL Bubble Level Marker

S9-2070

Overall Length: 120mm



Bi-Manual Handpiece

23ga

SC-1003 Complete Set

Overall Length: 37mm

SC-1004 Aspiration

Overall Length: 37mm

SC-1004A Irrigation

Overall Length: 37mm



Bishop-Harmon Anterior Chamber Irrigator

SC-1005 Complete Set, Overall Length: 42mm

SC-1010 Silicone Bulb, Overall Length: 55mm

SC-1015 Bulb Adaptor, Overall Length: 25mm

SC-1020 Irrigation Cannula 19ga, Overall Length: 28mm

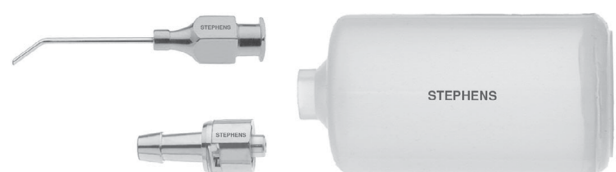

Bracken Irrigating Cannula

SC-1025

Overall Length: 43mm

Anterior Chamber

19ga

Curved



Gills Irrigating Cannula

SC-1065

Overall Length: 40mm
25ga Angled, 8mm



Welsh Flat Olive Tip

SC-1066

Overall Length: 43mm
25ga, Straight



Hirschman Irrigating Cannula

Spatulated Tip, 23ga

SC-1075 Right

Overall Length: 33mm

SC-1080 Left

Overall Length: 32mm



Knolle Irrigating Cannula



SC-1095 30ga

Overall Length: 37mm



SC-1100 23ga

Overall Length: 38mm



SC-1101 25ga

Overall Length: 38mm

Knolle-Pearce Vectis Cannula

23ga

SC-1105 3 Irrigation Holes

Overall Length: 38mm

SC-1106 1 Straight & 2 Reverse Holes

Overall Length: 51mm



Heart-Shaped Vectis Irrigation Cannula

SC-1107

Overall Length: 52mm
2 Irrigation Holes
23ga



Kratz Irrigating Cannula

SC-1110

Overall Length: 35mm
Sand-Blasted Tip
23ga



Anterior Chamber Cannula

Straight

SC-1115 23ga

Overall Length: 33mm

SC-1125 26ga

Overall Length: 36mm

SC-1135 30ga

Overall Length: 38mm



Anterior Chamber Cannula

Angled

SC-1120 23ga

Overall Length: 32mm

SC-1130 26ga

Overall Length: 33mm

SC-1140 30ga

Overall Length: 32mm



Infusion Hand Piece

SC-1180

Overall Length: 95mm

Autoclavable



Scheie Anterior Chamber Cannula

SC-1185

Overall Length: 36mm

27ga, Blunt



Sheets Irrigating Vectis Cannula

SC-1190

Overall Length: 50mm

3 Holes

16ga



West Irrigating Cannula

SC-1220

Overall Length: 44mm

Built Tip, Side Opening

20ga



Wills Eye Irrigating Cannula

SC-1225

Overall Length: 37mm

21ga



Healon Aspirating Cannula

SC-1315

Overall Length: 38mm

Angled

22ga



Inner Irrigation Cannula

23ga

SC-1365 0.2mm Port

Overall Length: 64mm

SC-1370 0.3mm Port

Overall Length: 66mm

SC-1375 Front Opening

Overall Length: 65mm

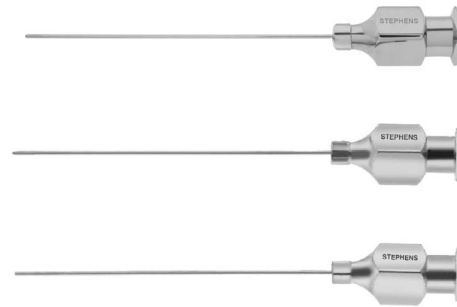

Outer Aspirating Cannula

19ga

SC-1380 Truncated Tip

Overall Length: 32mm

SC-1385 Straight, Blunt

Overall Length: 36mm



Bonn Lacrimal Cannula

SC-1430

Overall Length: 42mm

22ga



Bailey Infant & Child Lacrimal Cannula

SC-1435

Overall Length: 32mm

23ga, Blunt



Fasanella Lacrimal Cannula

SC-1475

Overall Length: 38mm

Light Curve 22m Tip

23ga



Keislar Lacrimal Cannula

SC-1480

Overall Length: 42mm
23ga, Curved



Lacrimal Cannula

SC-1490

Overall Length: 39mm
Bevelled, Round
23ga



Lacrimal Cannula

SC-1500

Overall Length: 36mm
Bevelled, Short Angle
23ga



Lacrimal Cannula

SC-1515

Overall Length: 27mm
23ga, Straight



Lacrimal Cannula

SC-1525

Overall Length: 40mm
19ga, Straight, Closed Front



Lacrimal Cannula

23ga, Reinforced Tip

SC-1530 Straight

Overall Length: 47mm

SC-1535 Curved

Overall Length: 45mm



Lacrimal Cannula

Side Port, 23ga x 0.3mm

SC-1540 Curved

Overall Length: 60mm

SC-1545 Straight

Overall Length: 60mm

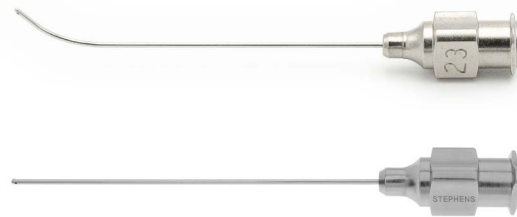

West Lacrimal Cannula

SC-1560

Overall Length: 47mm

Side Port, 23ga



Atkinson Retrobulbar Needle

SC-1580

Overall Length: 53mm

23ga, Sharp-Rounded Tip



Retrobulbar Injection Cannula

23ga

SC-1585 0.6 x 60mm

Overall Length: 78mm

SC-1590 0.5 x 50mm

Overall Length: 68mm

SC-1595 0.5 x 40mm

Overall Length: 61mm

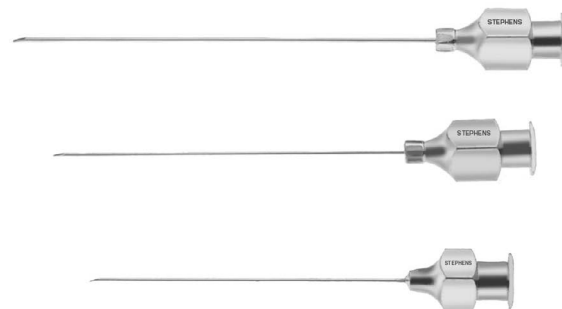

Air Injection Cannula

Smooth Angled Tip

SC-1625 30ga

Overall Length: 39mm

SC-1630 27ga

Overall Length: 36mm



Rainin Air Injection Cannula

Spatulated Tip

SC-1645 30ga

Overall Length: 36mm

SC-1650 27ga

Overall Length: 23mm

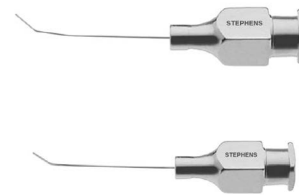

Cystotome Irrigation Cannula

SC-1660

Overall Length: 32mm

27ga



Kelman Cystotome Knife Cannula

22ga

SC-1670 Blunt

Overall Length: 46mm

SC-1675 Sharp

Overall Length: 48mm

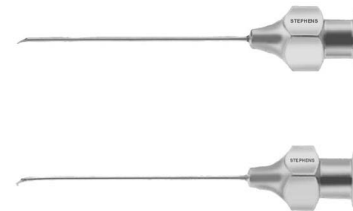

Binkhorst Irrigating Hooked Cannula

SC-1815

Overall Length: 46mm

Straight

22ga



Binkhorst Irrigating Hooked Cannula

25ga

SC-1820 Angled, Left

Overall Length: 37mm

SC-1825 Angled, Right

Overall Length: 35mm

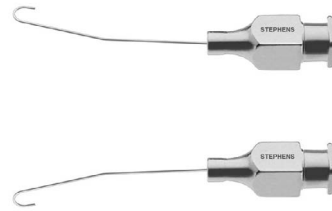

Jensen Posterior Capsule Polisher

SC-1835

Overall Length: 48mm

23ga, Sandblasted Tip



Capsule Polisher

Posterior Capsule Wall Scraper-Polisher

SC-1850 23ga x 2mm

Sand Blasted Tip

Overall Length: 40mm

SC-1855 30ga x 2mm

Sand Blasted Tip

Overall Length: 33mm



Kratz Capsule Wall Scraper

SC-1865

Overall Length: 39mm

23ga, Angled 1mm



Stephens A/C Maintainer

SC-1887

Overall Length: 34mm

20ga



Graether Collar Button Iris Retractor Cannula

23ga, Iris Cannula

SC-1901 Straight

Overall Length: 45mm

SC-1903 Vaulted

Overall Length: 45mm



Simcoe Cortex Cannula

SC-1905

Overall Length: 28mm

23ga, Blunt, Side Port



Simcoe Double Barrel I/A Cannula

SC-1906

Overall Length: 35mm

23ga, 0.3mm Port



Reverse Simcoe I/A Unit

SC-1907

Overall Length: 35mm

23ga



Kerichoff Aspiration & Irrigation Cannula

SC-1908

Overall Length: 46mm

23ga



Simcoe Capsule Scrubber

SC-1910

Overall Length: 32mm
23ga



Shahinian Cannula

SC-2005

Overall Length: 31mm
23ga



One Piece Phaco I/A Handpiece

16ga, 0.4mm

SC-3100 Straight

Overall Length: 136mm

SC-3105 Curved

Overall Length: 136mm



Chang Hydrodissection Cannula

SC-5335

Overall Length: 32mm
27ga



Pearce Nucleus Hydrodissector

SC-5340

Overall Length: 39mm
25ga



Sauter Nucleus Hydrodissector

SC-5360

Overall Length: 41mm



Flat End CCH Hydrodissector

SC-5380

Overall Length: 38mm
27ga



Cortical Cleaving Hydrodissection Cannula

SC-5385

Overall Length: 36mm
27ga



Pearce J-Shaped Hydrodissector

SC-5390

Overall Length: 41mm
25ga



J Shaped Hydrodissector

SC-5395

Overall Length: 41mm
27ga



Slade LASIK Cannula

SC-5575

Overall Length: 34mm
26ga



Buratto LASIK Irrigation Cannula

3 Irrigation Holes, Angled

SC-5580 23ga

Overall Length: 46mm

SC-5585 25ga

Overall Length: 43mm



Gimbel Lasik Irrigation Cannula

SC-5590

Overall Length: 33mm

Bullet Shaped

27ga



Gimbel Lasik Polishing Cannula

SC-5595

Overall Length: 31mm

27ga



Gulani Lasik Cannula

SC-5596

Overall Length: 50mm

Irrigation, Polishing, & Debris Removal

25ga



Lasik Aspirating Spoon Cannula

SC-5597

Overall Length: 60mm

Debris Removal under Flap

23ga



Hersch Lasik Flap Positioner Cannula

SC-5600

Overall Length: 41mm

Flattened Tip

45deg Angle

25ga



Nichamin Lasik Flap Positioner Cannula

Flattened Tip, Front Opening

9mm Tip for Elevation

SC-5602 23ga

Overall Length: 49mm

SC-5603 25ga

Overall Length: 50mm

SC-5604 27ga

Overall Length: 40mm

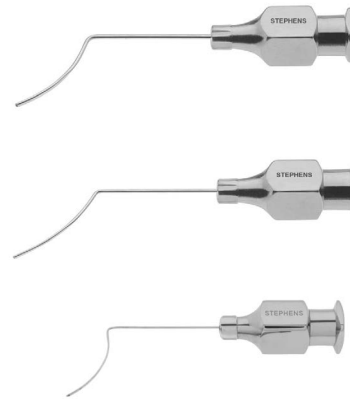

Vidaurri LASIK Flap Irrigator

SC-5605

Overall Length: 43mm

16ga



DALK Cannula

SC-5700

Overall Length: 39mm

27ga



Blade Handle

AD-1000 Handle No. 3

For blade #10, 11, 12, and 15

Overall Length: 128mm

AD-1005 Handle No. 7

Overall Length: 128mm

AD-1010 Handle No. 4

Overall Length: 128mm

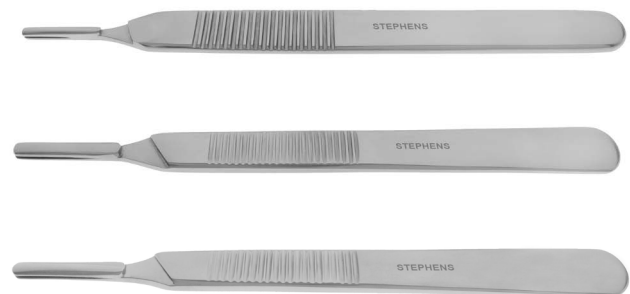

Beaver Blade Handle

AD-1036

Overall Length: 110mm



Plastic Sterilization Tray

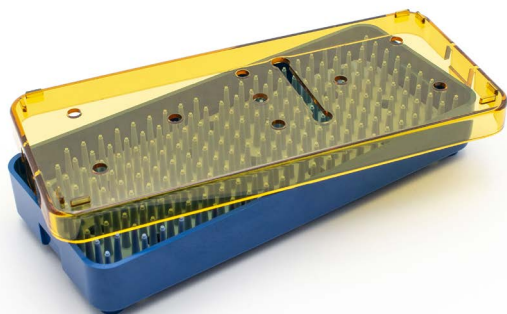

T1-0001

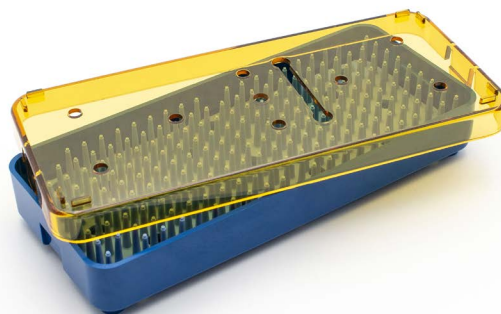

T1-0002

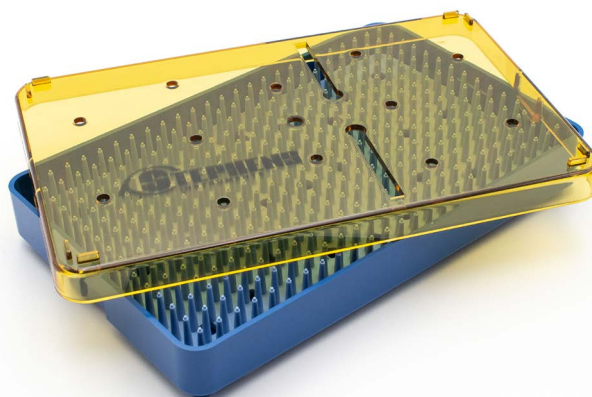

T1-0003

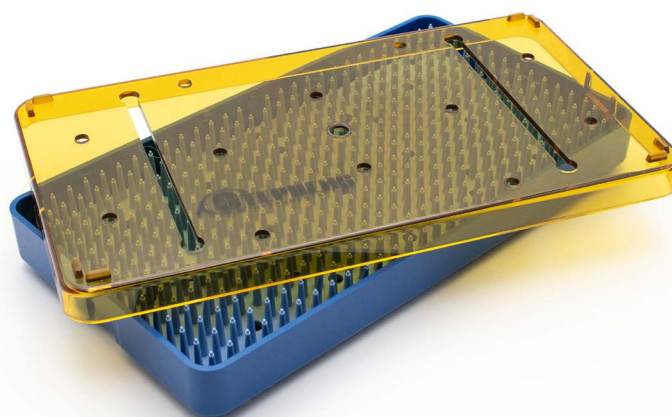

T1-0004

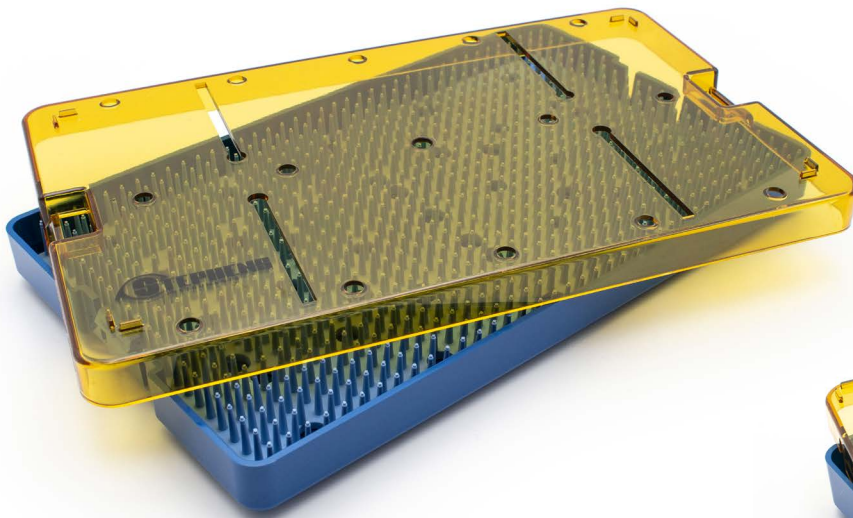

T1-0005

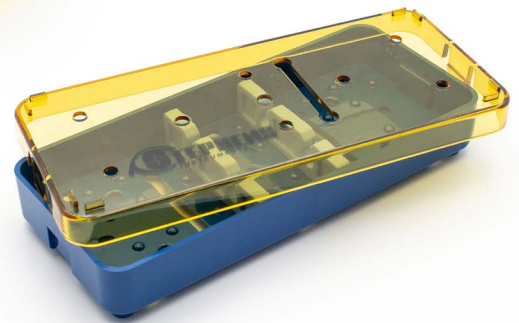

T1-0007

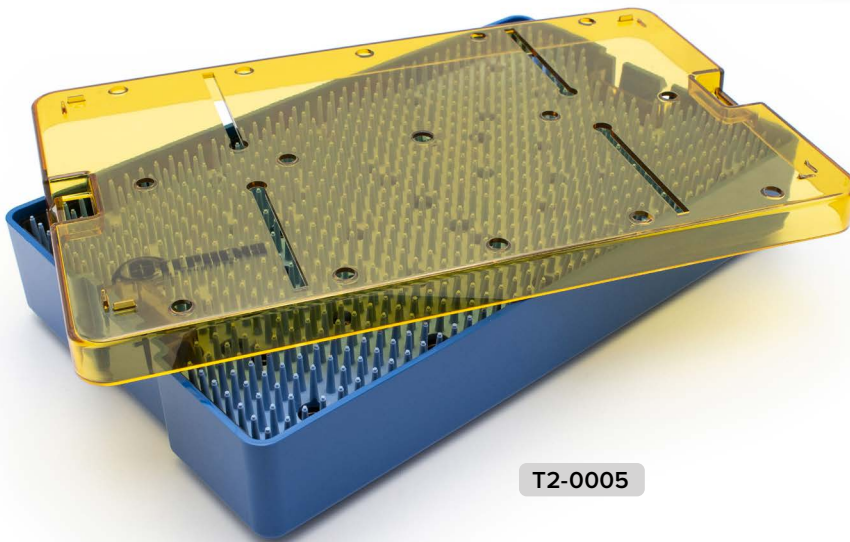

T2-0005

PLASTIC STERILIZATION TRAYS

T1-0001	2.5" x 6" x 0.75"		Silicone Inlay
T1-0002	2.5" x 7.5" x 0.75"		Silicone Inlay
T1-0003	4" x 6.5" x 0.75"		Silicone Inlay
T1-0004	4" x 7.5" x 0.75"		Silicone Inlay
T1-0005	6" x 10" x 0.75"		Silicone Inlay
T1-0007	2.5" x 6" x 0.75"		Silicone Bars
T2-0005	6" x 10" x 1.5"	Double Level	Silicone Inlay



Speculums	122
Manipulator, Hook, Caliper	122
Forceps	124
Needle Holder	128

Titanium Instruments



Lieberman Speculum K-Wire

ST1-1026

Overall Length: 78mm

Titanium



Thornton Fixation Ring

ST1-1211A

Overall Length: 105mm

Titanium



Iris Spatula

ST4-1040

Overall Length: 120mm

Titanium

Smooth, Round



Bechert Nucleus Rotator

ST4-1070

Overall Length: 120mm

Titanium

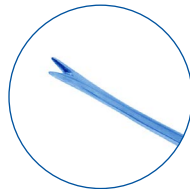

Castroviejo Cyclodialysis Spatula

ST4-1140

Overall Length: 127mm

Titanium

0.75mm



New Orleans Lens Loop

ST4-1170

Overall Length: 134mm

Titanium



Lester Lens Manipulator

Titanium

ST4-1371 Straight

Overall Length: 118mm

ST4-1372 Angled

Overall Length: 115mm

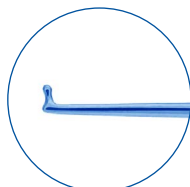

Sinskey Hook

Titanium

ST4-1386 Straight

Overall Length: 115mm

ST4-1387 Angled

Overall Length: 115mm

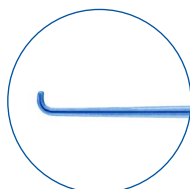

Castroviejo Caliper

ST4-1455

Overall Length: 87mm

Titanium



Buratto Flap Protector

ST4-1660

Overall Length: 114mm

Titanium



Katzen LASIK Flap Unzipper

ST4-1665

Overall Length: 112mm

Titanium



Seibel II Intralase Flap Lifter & Retreatment Spatula

ST4-1720

Overall Length: 104mm
Titanium



Desmarres Chalazion Forceps

ST5-1025

Overall Length: 90mm
Titanium



Francis Chalazion Forceps

ST5-1045

Overall Length: 97mm
Titanium



Barraquer Cilia Forceps

ST5-1085

Overall Length: 108mm
Titanium

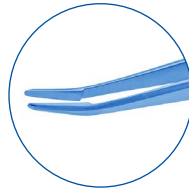

Colibri Forceps

ST5-1120

Overall Length: 75mm
Titanium
0.12mm

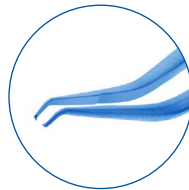

Colibri Forceps

ST5-1125

Overall Length: 77mm
Titanium
0.12mm Tip
45 Degree Angled

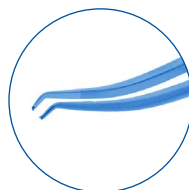

Castroviejo Colibri

ST5-1145

Overall Length: 108mm
 Titanium
 0.12mm

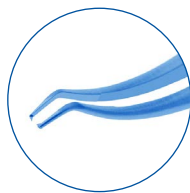

Bonn Forceps

ST5-1245

Overall Length: 85mm
 Titanium
 0.12mm
 Long Model

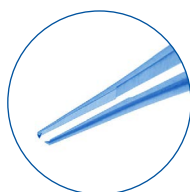

Bonn Forceps

ST5-1250

Overall Length: 76mm
 Straight
 Serrated Tip

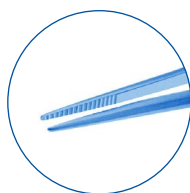

Bishop-Harmon Iris Forceps

Titanium, 1x2 Teeth

ST5-1365 0.8mm

Overall Length: 88mm

ST5-1370 0.3mm

Overall Length: 87mm

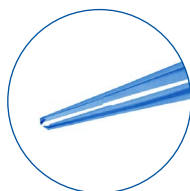
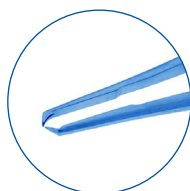

Castroviejo Suturing Forceps

Titanium

ST5-1560 0.12mm

Overall Length: 105mm

ST5-1570 0.3mm

Overall Length: 105mm

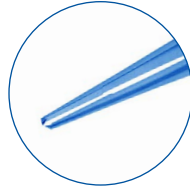
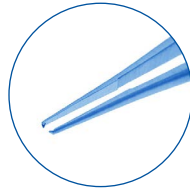
**Utrata Capsulorhexis Forceps****ST5-1601**

Overall Length: 103mm

Titanium

Round Handle

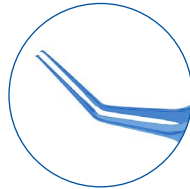
**Masket Capsulorhexis Forceps****ST5-1602**

Overall Length: 103mm

Titanium

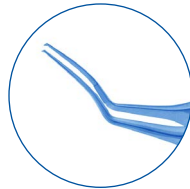
**Utrata Capsulorhexis Forceps****ST5-1603**

Overall Length: 104mm

Titanium

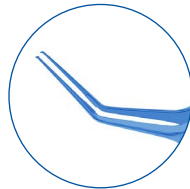
**Utrata Capsulorhexis Forceps****ST5-1611**

Overall Length: 105mm

Titanium

Inamura, Cross-Action

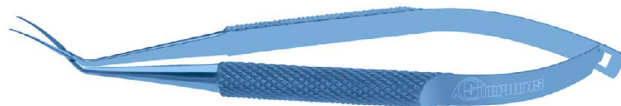
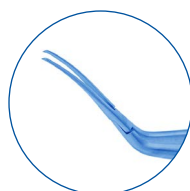

Micro-Incision Capsulorhexis Forceps

ST5-1612

Overall Length: 104mm

Titanium

2mm Depth Control

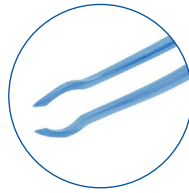

MICS Capsulorhexis Forceps

ST5-1613

Overall Length: 104mm

Titanium

Guide Marks

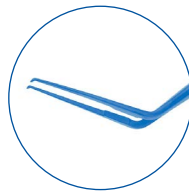

Kelman-McPherson Tying Forceps

ST5-1630

Overall Length: 107mm

Titanium

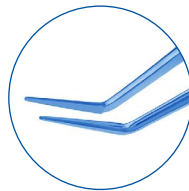

McPherson Tying Forceps

Titanium

ST5-1650 Straight

Overall Length: 109mm

ST5-1655 Angled

Overall Length: 109mm

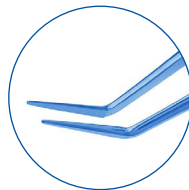
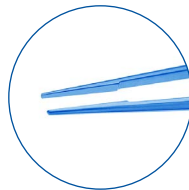

Tennant Tying Forceps

Titanium

ST5-1670 Straight

Overall Length: 103mm

ST5-1675 Curved

Overall Length: 102mm

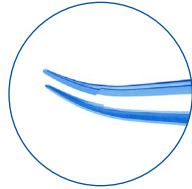
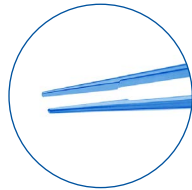

Stephens Soft IOL Insertion Forceps

ST5-1802

Overall Length: 107mm

Titanium



Humer Lens Folding Forceps

ST5-1804

Overall Length: 110mm

Titanium

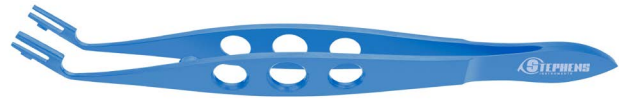

Akahoshi Pre-Chop

ST5-1903C

Overall Length: 120mm

Titanium

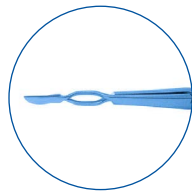

Barraquer Needle Holder

Titanium, Standard Jaws, Curved

ST6-1000 without Lock

Overall Length: 137mm

ST6-1005 with Lock

Overall Length: 134mm



Barraquer Needle Holder

ST6-1006

Overall Length: 118mm

Titanium

Heavy Jaws

Straight, with Lock



Castroviejo Needle Holder

Titanium, Standard Jaws, Straight

ST6-1050 with Lock

Overall Length: 120mm

ST6-1051 without Lock

Overall Length: 122mm

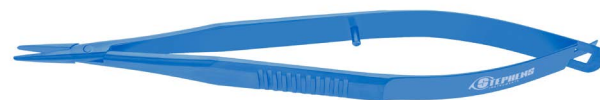

Stephens Needle Holder

Titanium, Delicate Jaws

ST6-1120 Straight, with Lock

Overall Length: 125mm

ST6-1125 Curved, without Lock

Overall Length: 122mm



IOL Scissors

ST7-1400

Overall Length: 89mm

Notched Blades

18ga

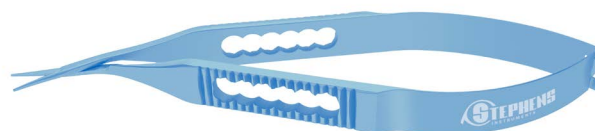



Microsurgical Instruments

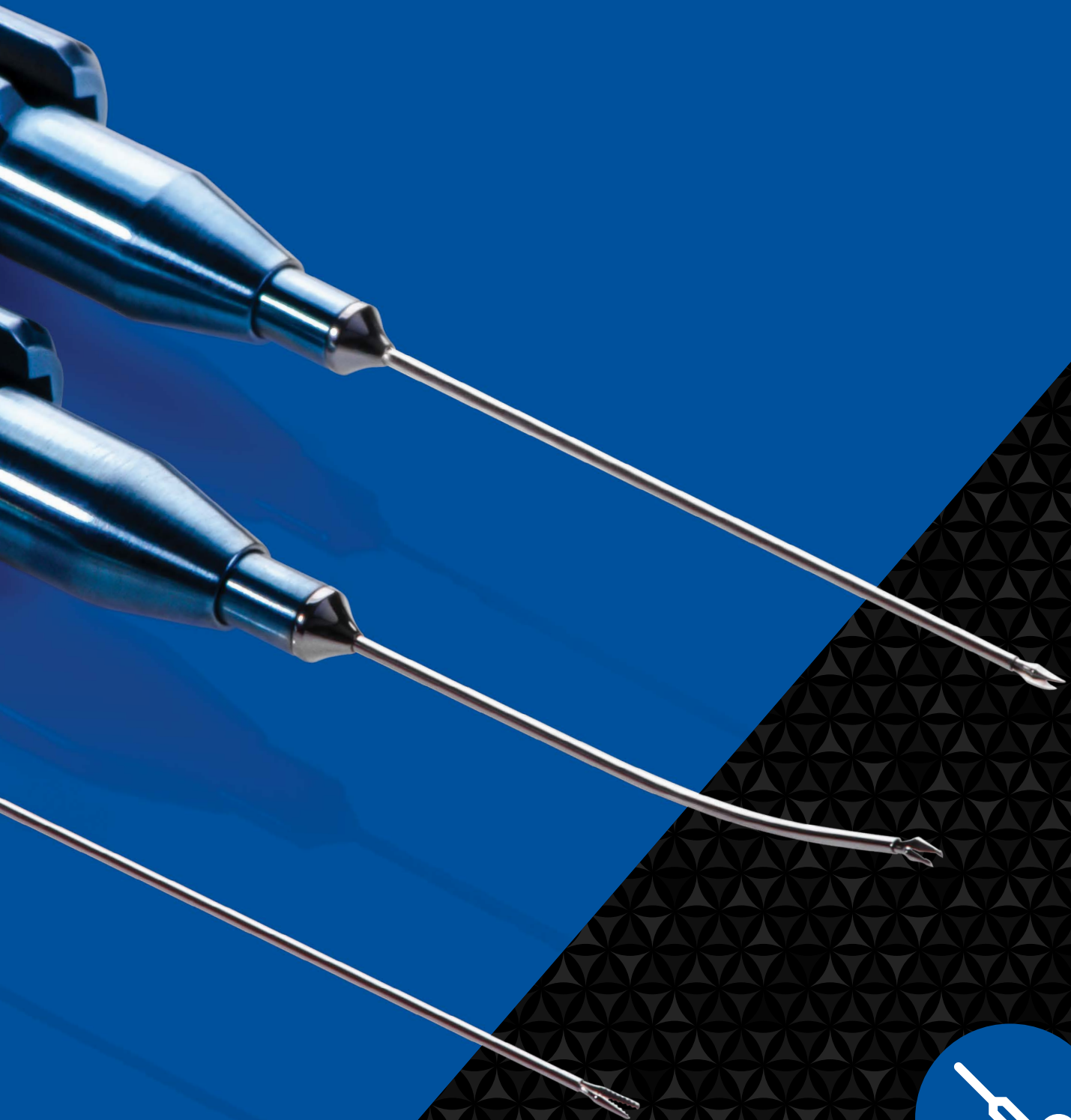

Microsurgical Instruments



ST5-7000



ST5-7005

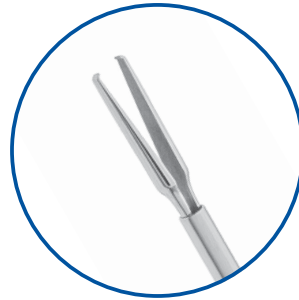

ST5-7010



ST5-7035



ST5-7040



ST5-7050/56

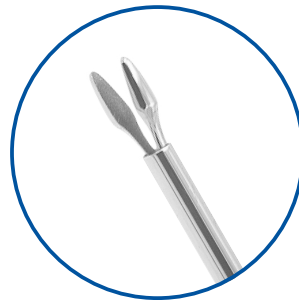

ST5-7060



ST5-7065



ST5-7070



ST7-1410



ST7-1715



ST7-1720

FORCEPS

Serrated Gripping Forceps, 1.5mm tip	23/25ga	ST5-7000
Micro Gripping Forceps, 3mm tip	23/25ga	ST5-7005
Micro Gripping Forceps, 1.2mm tip	23/25ga	ST5-7010
Capsulorhexis Utrata Forceps	23ga	ST5-7035
Eckhardt End Gripping Forceps	23ga	ST5-7040
Asymmetrical Forceps	23ga	ST5-7050
Asymmetrical Forceps	25ga	ST5-7056
DSAEK Corneal Forceps	23ga	ST5-7060
ILM Peeling Forceps	23ga	ST5-7065
IOL Holding Forceps, Grooved Jaws	20ga	ST5-7070

SCISSORS

IOL Cutting Scissors	18ga	ST7-1410
Horizontal Cutting, Curved	23ga	ST7-1715
Horizontal Cutting, Straight, 2.5mm tip	23ga	ST7-1720

Serrated Gripping Forceps

Titanium, 1.5mm Tip

ST5-7000-23 23ga

Overall Length: 144mm

ST5-7000-25 25ga

Overall Length: 144mm



Micro Gripping Forceps

Titanium, 3mm Tip

ST5-7005-23 23ga

Overall Length: 153mm

ST5-7005-25 25ga

Overall Length: 153mm

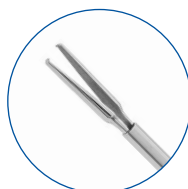

Micro Gripping Forceps

Titanium, 1.2mm Tip

ST5-7010-23 23ga

Overall Length: 144mm

ST5-7010-25 25ga

Overall Length: 144mm

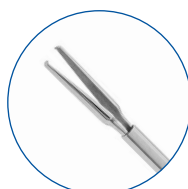

Capsulorhexis Utrata Forceps

ST5-7035

Overall Length: 150mm

Titanium

23ga



Eckhardt End Gripping Forceps

ST5-7040

Overall Length: 144mm

Titanium

23ga

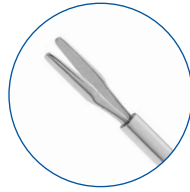

Asymmetrical Forceps

Titanium

ST5-7050 23ga

Overall Length: 138mm

ST5-7056 25ga

Overall Length: 138mm



DSAEK Corneal Forceps

ST5-7060

Overall Length: 150mm

Titanium

23ga



ILM Peeling Forceps

ST5-7065

Overall Length: 144mm

Titanium

23ga

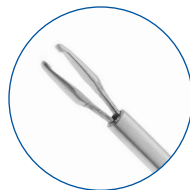

IOL Holding Forceps

ST5-7070

Overall Length: 141mm

Titanium

20ga

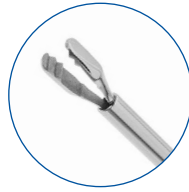

IOL Cutting Scissors

ST7-1410

Overall Length: 143mm

Titanium

18ga



Horizontal Cutting Scissors

Titanium, 23ga

ST7-1715 Curved

Overall Length: 150mm

ST7-1720 Straight

Overall Length: 144mm

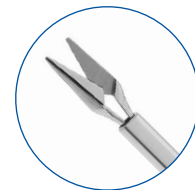
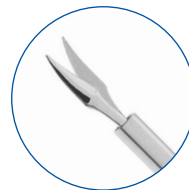



Instrument Sets

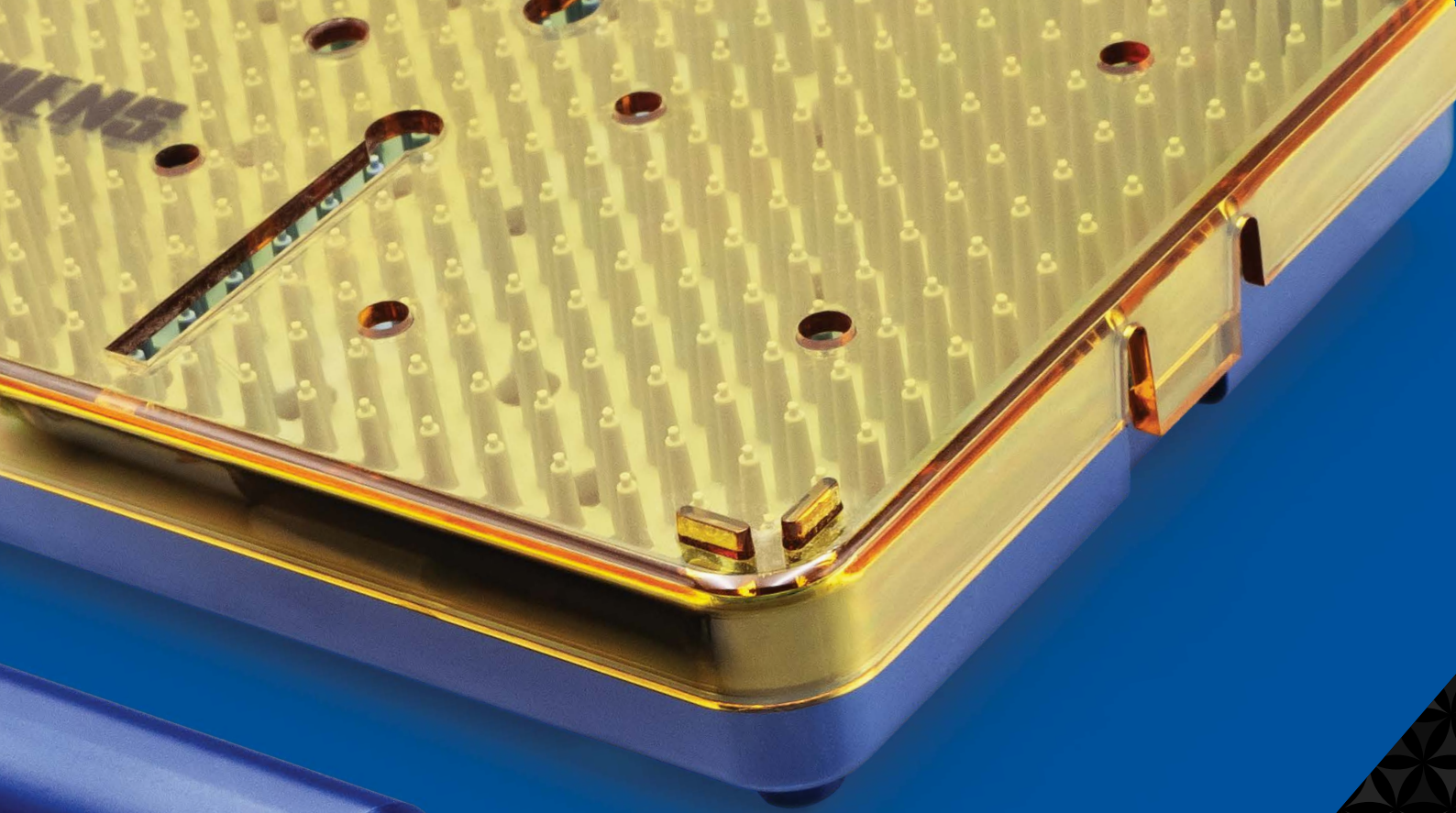

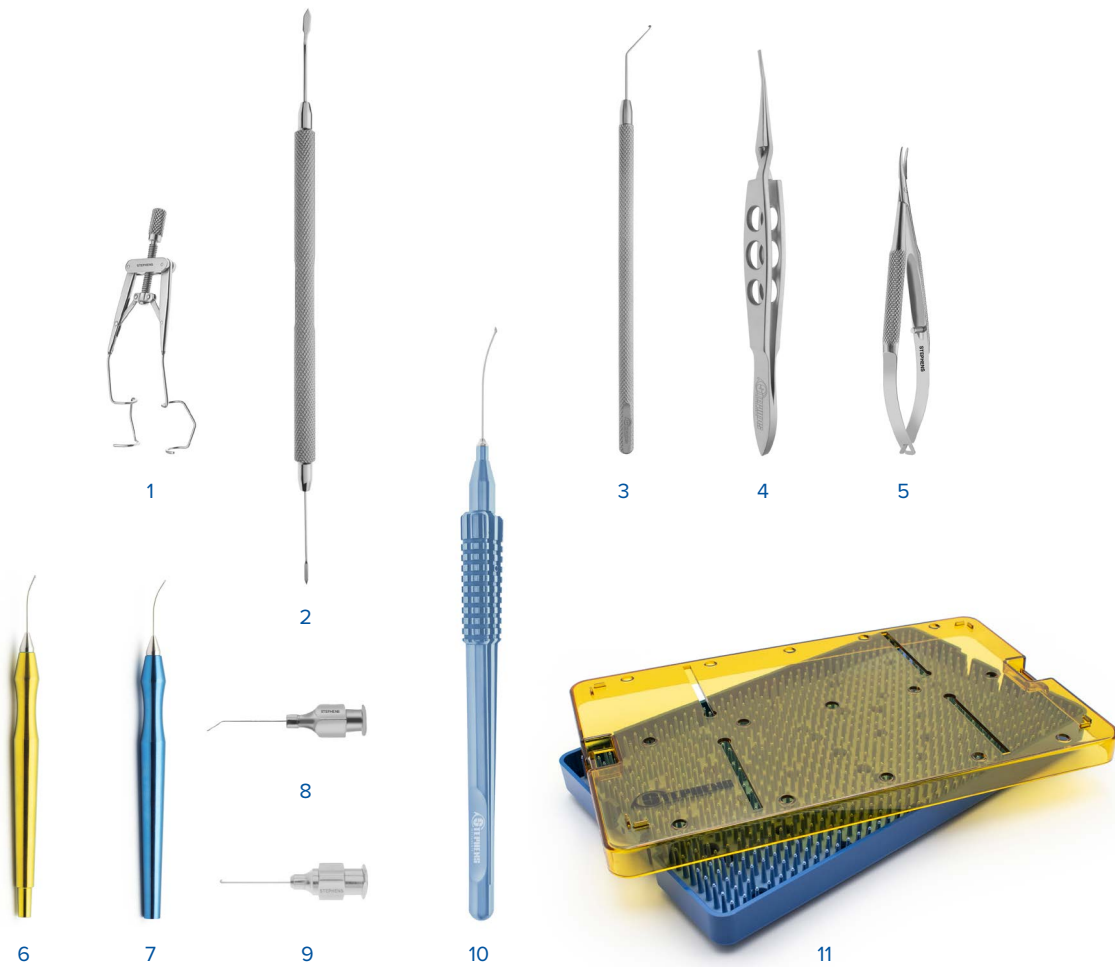

Femto Cataract Set

- | | | |
|----|-----------------|--|
| 1 | S1-1027 | Lieberman Speculum |
| 2 | S4-1700 | Double Ended Femtosecond Spatula |
| 3 | S4-1710 | Solomon Femto Chopper |
| 4 | S5-1535 | Femto LRI Enhancement Forceps |
| 5 | S6-1040 | Barraquer Short Needle Holder |
| 6 | SC-1004 | Bi-Manual Aspiration Cannula, 23ga |
| 7 | SC-1004A | Bi-Manual Irrigating Cannula, 23ga |
| 8 | SC-1630 | Air Injection Cannula, Smooth Angled Tip, 27ga |
| 9 | SC-5335 | Chang Hydrodissection Cannula |
| 10 | ST5-7035 | Titanium Capsulorhexis Utrata Forceps, 23ga |
| 11 | T1-0005 | Plastic Instrument Tray, 6" x 10" x 0.75" |

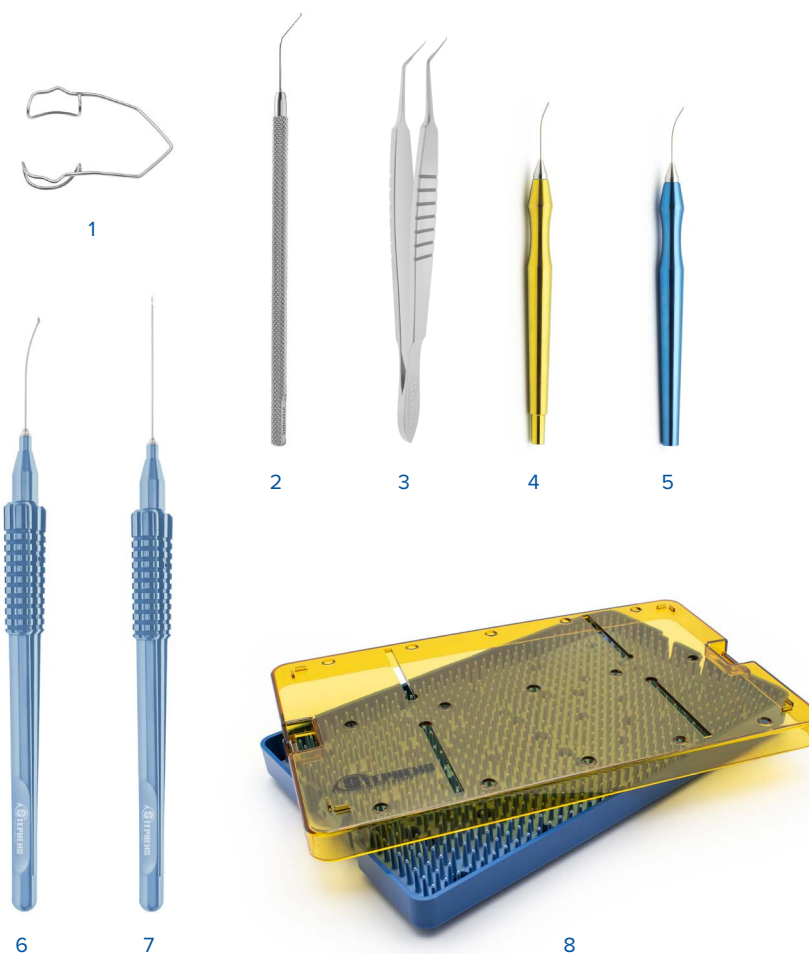

Micro Incision Cataract Set (MICS)

- | | | |
|---|-----------------|---|
| 1 | S1-1020 | Grandon-Barraquer Speculum |
| 2 | S4-1372 | Lester Lens Manipulator, Angled |
| 3 | S5-1613 | Mics Capsulorhexis Forceps, Sharp Tip, With Guide Marks |
| 4 | SC-1004 | Bi-Manual Aspiration Cannula, 23ga |
| 5 | SC-1004A | Bi-Manual Irrigating Cannula, 23ga |
| 6 | ST5-7035 | Titanium Capsulorhexis Ultrata Forceps, 23ga |
| 7 | ST7-1715 | Titanium Horizontal Cutting Scissors, Curved, 23ga |
| 8 | T1-0005 | Plastic Instrument Tray, 6" x 10" x 0.75" |

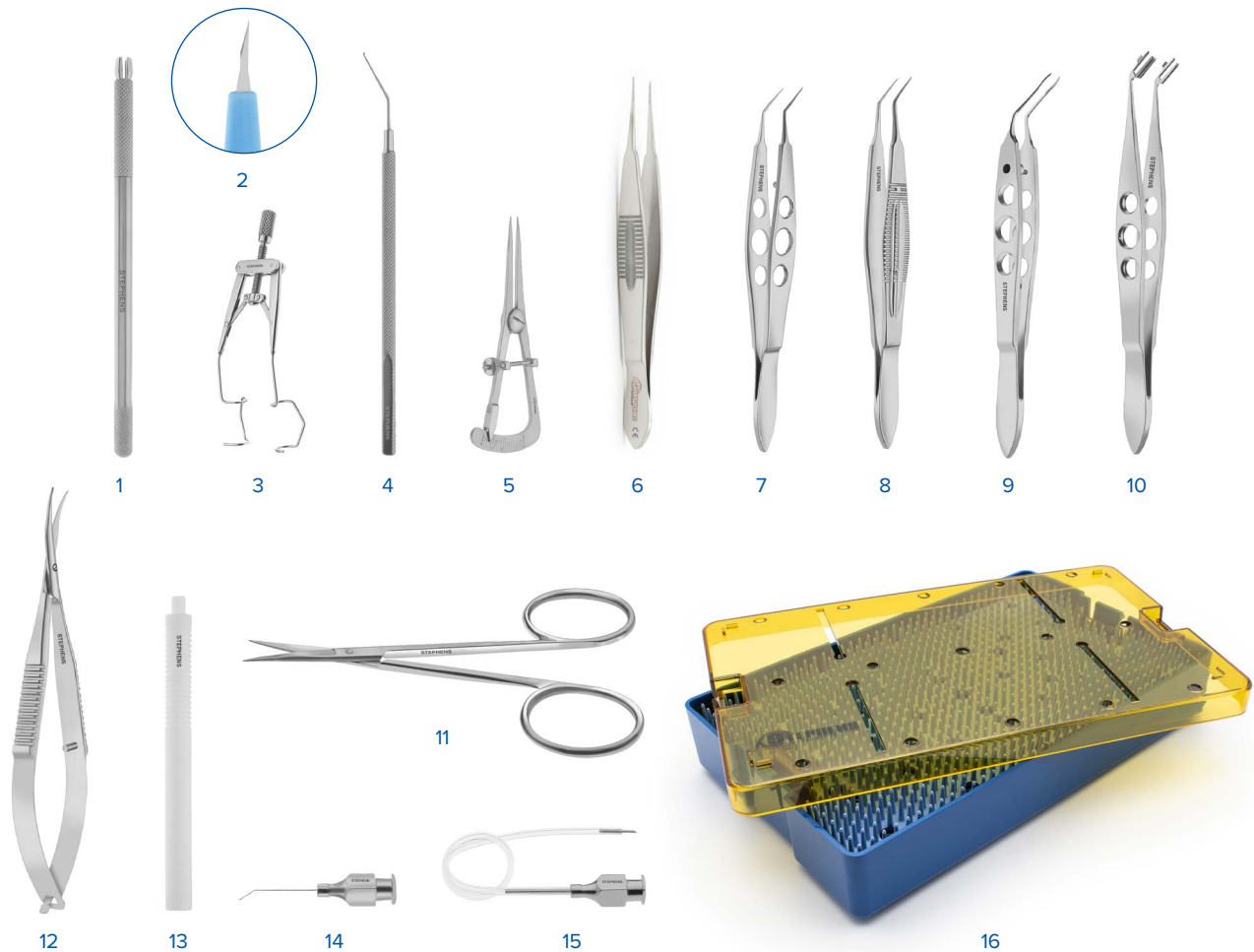

Cataract – Manual

- | | | |
|----|----------------|--|
| 1 | AD-1036 | Blade Handle, 3-Piece For Beaver |
| 2 | R-1500 | 15 Degree Stab Knife |
| 3 | S1-1027 | Lieberman Speculum |
| 4 | S4-1370 | Kuglen Iris Hook Push-Pull Model, Angled |
| 5 | S4-1455 | Castroviejo Caliper, Straight, 20mm |
| 6 | S5-1560 | Castroviejo Suturing Forceps, 0.12mm, With Tying Platform |
| 7 | S5-1603 | Utrata Capsulorhexis Forceps, Flat Handle |
| 8 | S5-1605 | Gaskin Fragment Forceps, 11mm Jaws, With Platform, Very Delicate |
| 9 | S5-1802 | Stephens Soft Iol Insertion Forceps |
| 10 | S5-1804 | Humer Lens Folding Forceps |
| 11 | S7-1035 | Large Ring Scissors, Standard, Straight |
| 12 | S7-1325 | Westcott Tenotomy Scissors, Standard Blades, Blunt |
| 13 | SC-1180 | Infusion Hand Piece, Plastic, Autoclaveable |
| 14 | SC-1630 | Air Injection Cannula, Smooth Angled Tip, 27ga |
| 15 | SC-1887 | Stephens A/C Maintainer |
| 16 | T2-0005 | Plastic Instrument Tray, 6" x 10" x 1.5" (Double Level) |

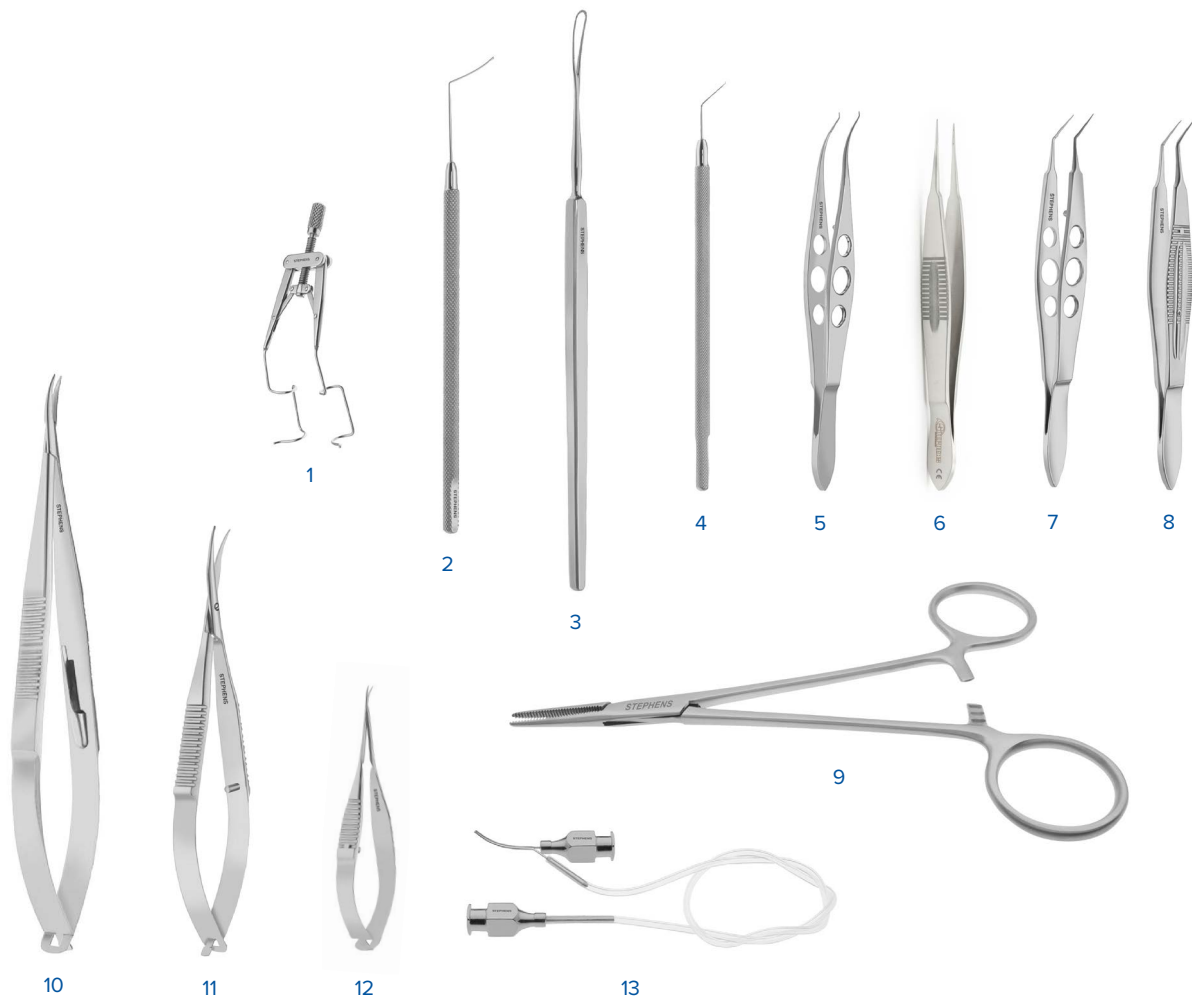

Cataract – MSICS

- 1 **S1-1026** Lieberman Adjustable Eye Speculum, K-Shaped Wire
- 2 **S4-1040** Barraquer Iris Spatula, Smooth, Round
- 3 **S4-1185** Wilder Serrated Lens Loop
- 4 **S4-1387** Sinskey II Lens Hook, 0.18mm Tip, Angled
- 5 **S5-1145** Castroviejo Colibri Forceps, 0.12mm, With Tying Platform
- 6 **S5-1560** Castroviejo Suturing Forceps, 0.12mm, With Tying Platform
- 7 **S5-1603** Utrata Capsulorhexis Forceps, Flat Handle
- 8 **S5-1605** Gaskin Fragment Forceps, 11mm Jaws, With Platform, Very Delicate
- 9 **S5-1915** Mosquito Hemostat, 12.5cm, Straight
- 10 **S6-1075** Castroviejo Needle Holder, Curved, With Lock, Delicate Jaws
- 11 **S7-1325** Westcott Tenotomy Scissors, Standard Blades, Blunt
- 12 **S7-1375** Vannas Capsulotomy Scissors, Curved, Sharp
- 13 **SC-1906** Simcoe Double Barrel I/A Cannula, 0.3mm Port, 23ga

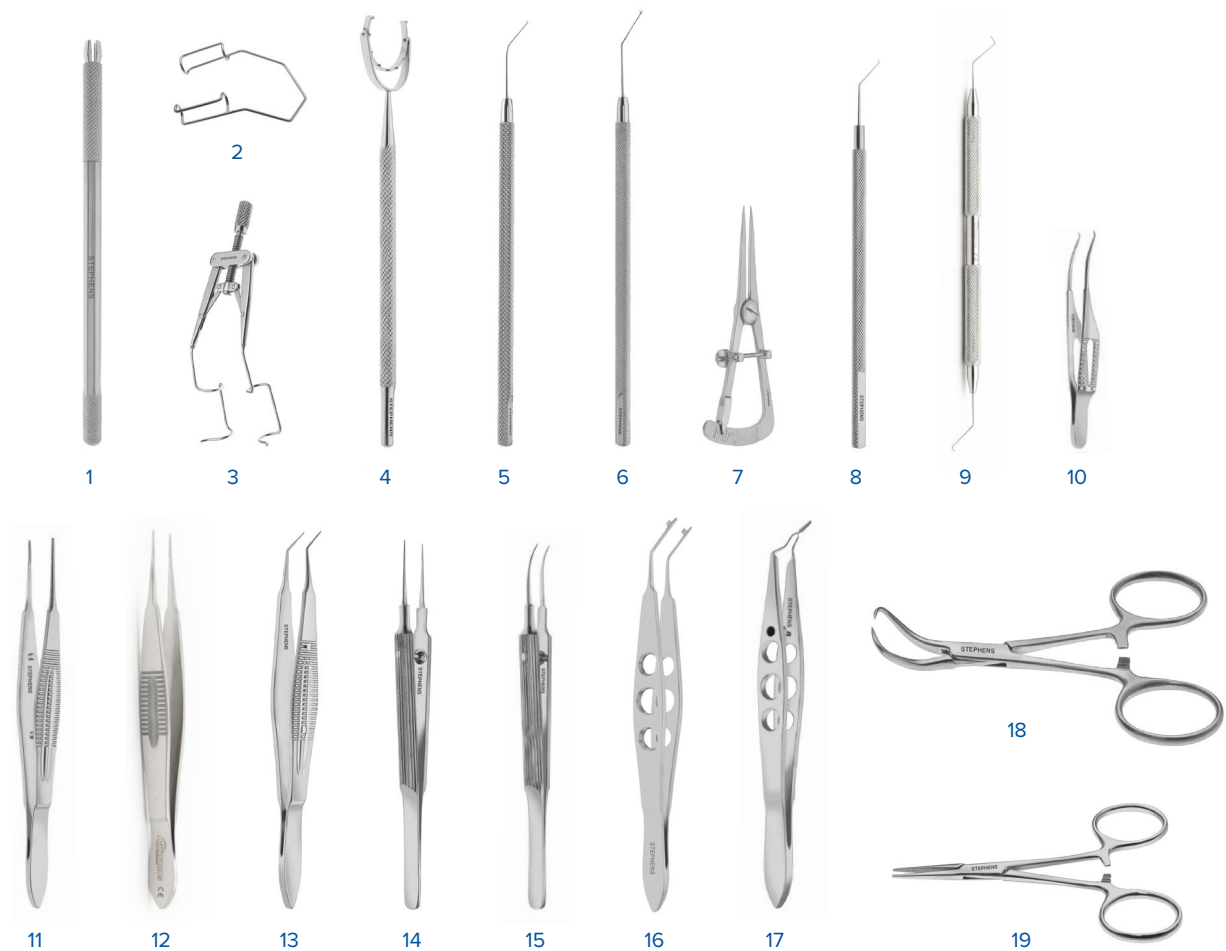

Extracap using Phaco

- | | | |
|----|-----------------|--|
| 1 | AD-1036 | Blade Handle, 3-Piece For Beaver |
| 2 | S1-1012 | Barraquer Wire Speculum, Adult, Temporal, 15mm |
| 3 | S1-1026 | Lieberman Adjustable Eye Speculum, K-Shaped Wire |
| 4 | S1-1211A | Thornton Fixation Ring, 12mm Swinging Handle, Open Ring 1/2 |
| 5 | S4-1372 | Lester Lens Manipulator, Angled |
| 6 | S4-1392 | Jaffe-Maltzman Lens Hook, V Shaped Tip, Angled |
| 7 | S4-1455 | Castroviejo Caliper, Straight, 20mm |
| 8 | S4-1550 | Nagahara Horizontal Chopper |
| 9 | S4-1554 | Chang-Seibel Chopper |
| 10 | S5-1120 | Barraquer Colibri Forceps, 0.12mm With Tying Platform |
| 11 | S5-1355 | Macgregor Conjunctiva Forceps, 6mm Tying Platform, Serrated Tips |
| 12 | S5-1560 | Castroviejo Suturing Forceps, 0.12mm, With Tying Platform |
| 13 | S5-1630 | Kelman-Mcpherson Tying Forceps, 8mm, Angled |
| 14 | S5-1670 | Tennant Tying Forceps, Round Hand, Straight, With Platform |
| 15 | S5-1675 | Tennant Tying Forceps, Round Hand, Curved, With Platform |
| 16 | S5-1794M | Livernois Lens Forceps, Modified |

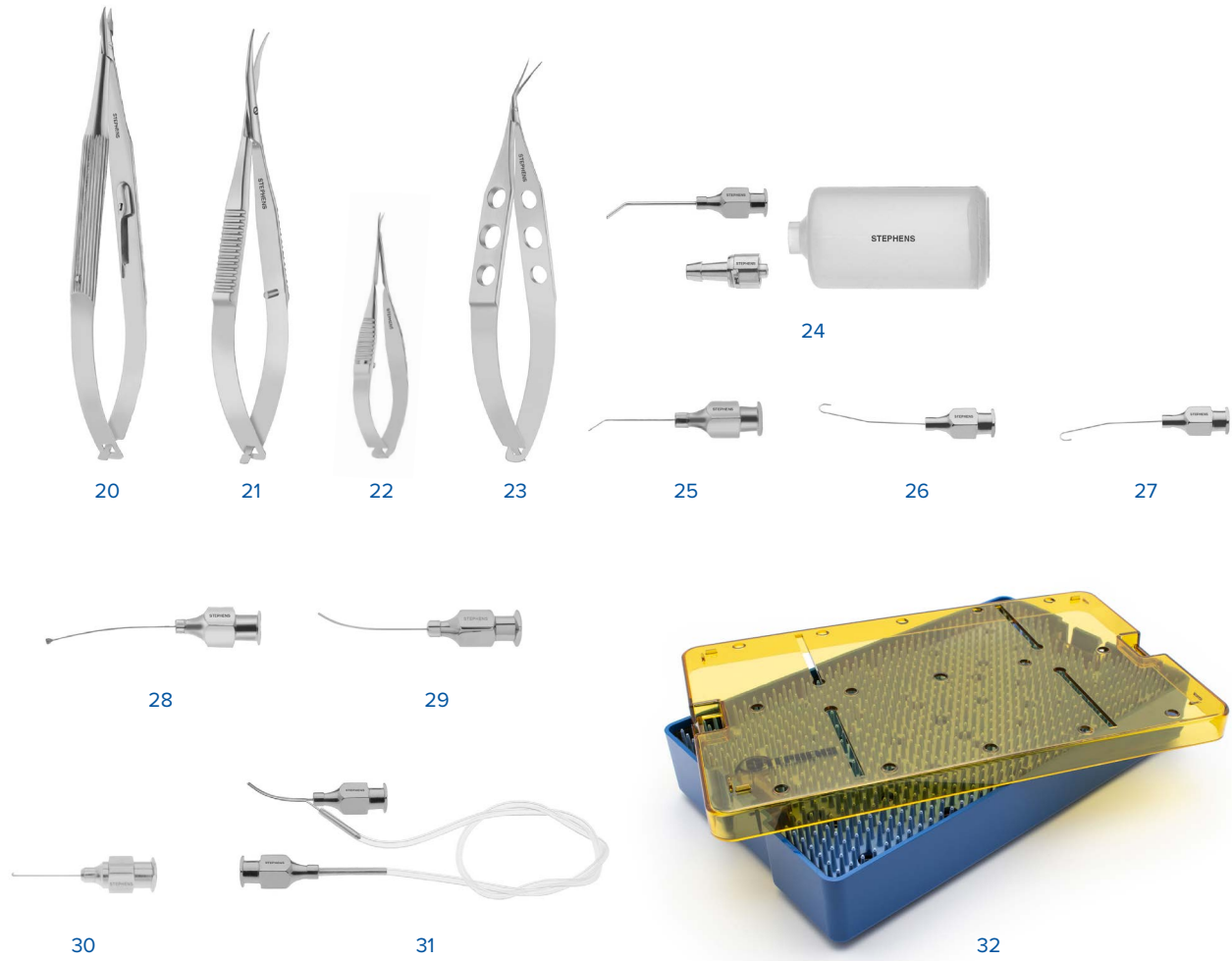

- 17 **S5-1798** Cross Action Lens Folding Forceps
- 18 **S5-1904A** Backhaus Towel Clamp
- 19 **S5-1905** Mosquito Hemostat, 9cm, Straight
- 20 **S6-1130** Stephens Needle Holder, Curved, With Lock, Very Delicate Jaws
- 21 **S7-1325** Westcott Tenotomy Scissors, Standard Blades, Blunt
- 22 **S7-1375** Vannas Capsulotomy Scissors, Curved, Sharp
- 23 **S7-1384** Stern-Gills Vannas Scissors, 11mm Blades
- 24 **SC-1005** Bishop-Harmon Anterior Chamber Irrigator, Complete Set
- 25 **SC-1630** Air Injection Cannula, Smooth Angled Tip, 27ga
- 26 **SC-1820** Binkhorst Irrigating Hooked Cannula, 22ga, Left
- 27 **SC-1825** Binkhorst Irrigating Hooked Cannula, 22ga, Right
- 28 **SC-1835** Jensen Post.Cap. Polisher, Sandblasted Tip, 23ga
- 29 **SC-1906** Simcoe Double Barrel I/A Cannula, 0.3mm Port, 23ga
- 30 **SC-5335** Chang Hydrodissection Cannula
- 31 **SC-5360** Sauter Nucleus Hydrodissector
- 32 **T2-0005** Plastic Instrument Tray, 6" x 10" x 1.5" (Double Level)

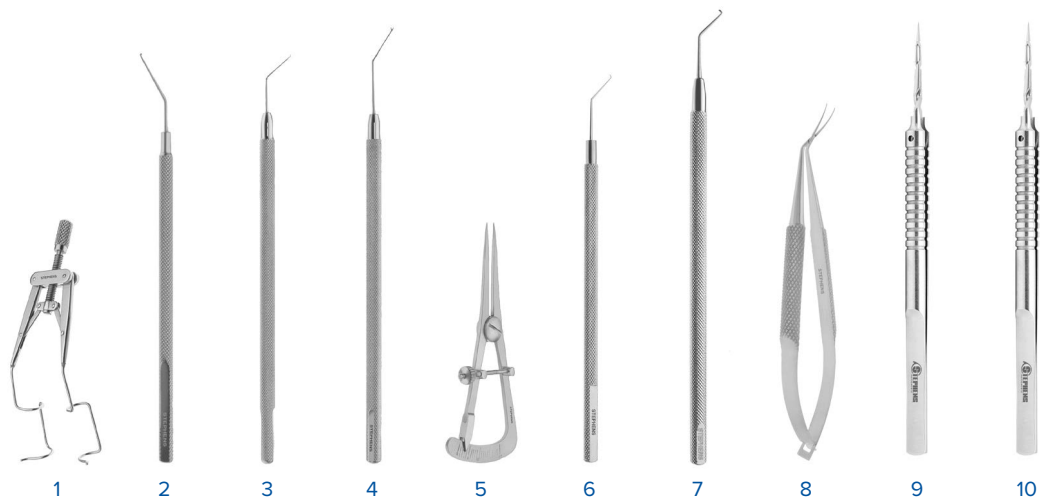

Phaco Prechop Set

- | | | |
|----|-----------------|--|
| 1 | S1-1026 | Lieberman Adjustable Eye Speculum, K-Shaped Wire |
| 2 | S4-1370 | Kuglen Iris Hook Push-Pull Model, Angled |
| 3 | S4-1387 | Sinsky li Lens Hook, 0.18mm Tip, Angled |
| 4 | S4-1392 | Jaffe-Maltzman Lens Hook, V Shaped Tip, Angled |
| 5 | S4-1455 | Castroviejo Caliper, Straight, 20mm |
| 6 | S4-1550 | Nagahara Horizontal Chopper |
| 7 | S4-1556 | Rosen Phaco Splitter |
| 8 | S5-1611 | Capsulorhexis Forceps, Inamura Style |
| 9 | S5-1903 | Stephens Phaco Pre-Splitter |
| 10 | S5-1903C | Akahoshi Pre-Chop, Combo Jaws |

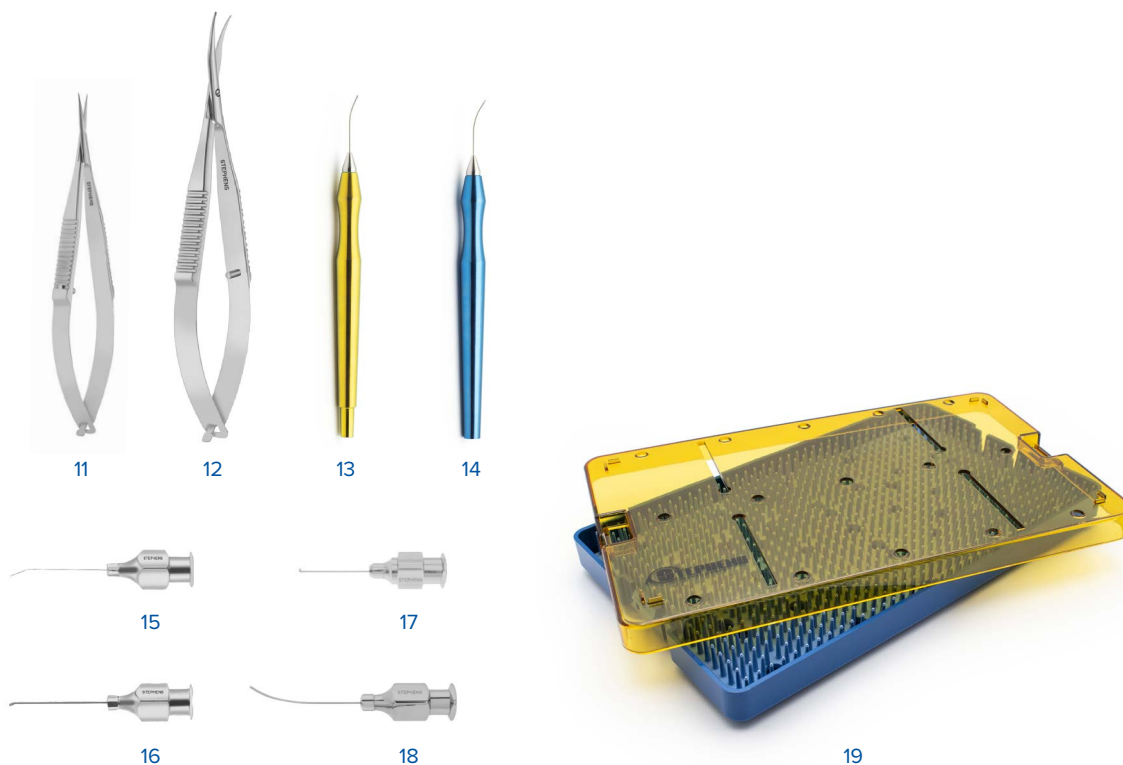

- 11 **S7-1315** Westcott Tenotomy Stitch Scissors, Standard Blades, Extra Sharp Tips
- 12 **S7-1325** Westcott Tenotomy Scissors, Standard Blades, Blunt
- 13 **SC-1004** Bi-Manual Aspiration Cannula, 23ga
- 14 **SC-1004A** Bi-Manual Irrigating Cannula, 23ga
- 15 **SC-1625** Air Injection Cannula, Smooth Angled Tip, 30ga
- 16 **SC-1865** Kratz Capsule Wall Scraper, 1mm Angled, 23ga
- 17 **SC-5335** Chang Hydrodissection Cannula
- 18 **SC-5360** Sauter Nucleus Hydrodissector
- 19 **T1-0005** Plastic Instrument Tray, 6" x 10" x 0.75"

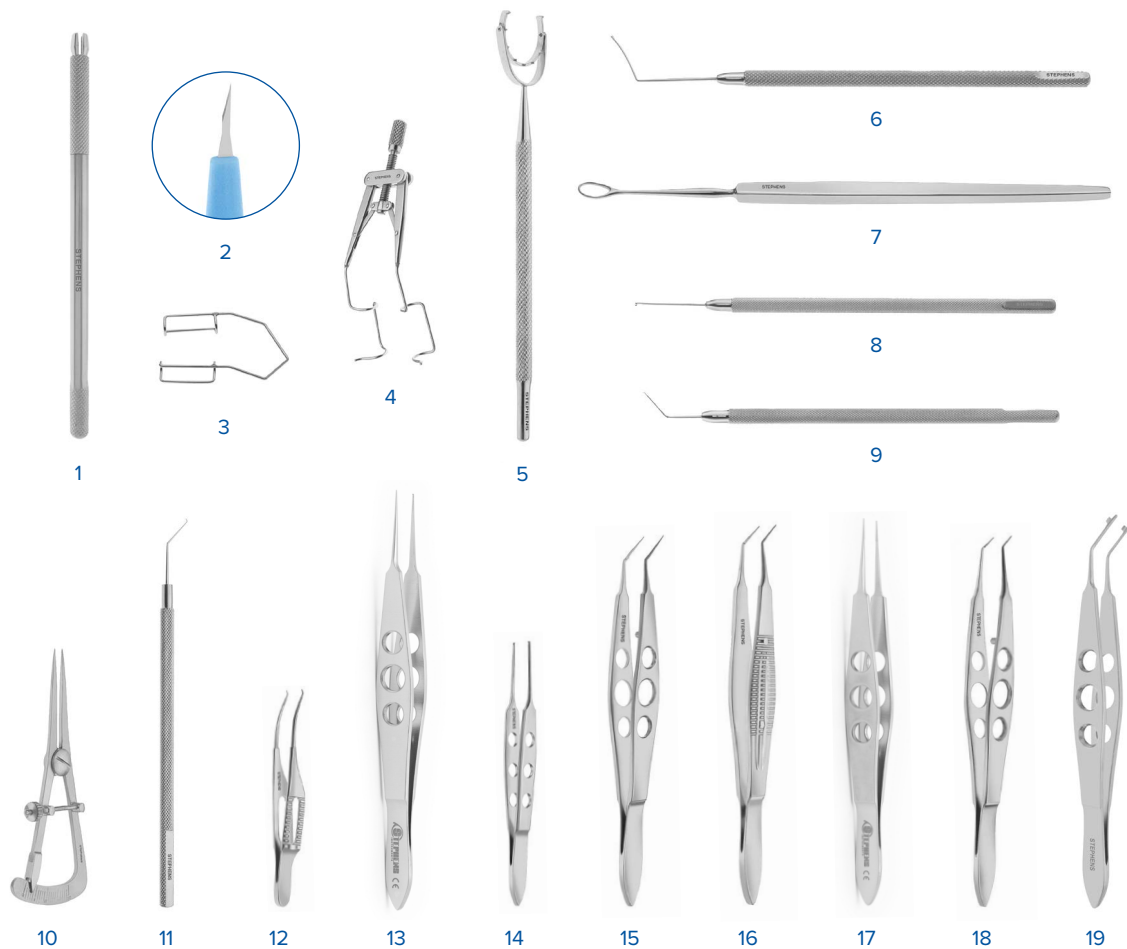

Planned Ecce Cataract

- | | | |
|----|-----------------|--|
| 1 | AD-1036 | Blade Handle, 3-Piece For Beaver |
| 2 | R-1500 | 15 Degree Stab Knife |
| 3 | S1-1005 | Barraquer Wire Speculum, Adult, 15mm |
| 4 | S1-1026 | Lieberman Adjustable Eye Speculum, K-Shaped Wire |
| 5 | S1-1211A | Thornton Fixation Ring, 12mm Swinging Handle, Open Ring 1/2 |
| 6 | S4-1040 | Barraquer Iris Spatula, Smooth, Round |
| 7 | S4-1165 | Lewis Lens Loop, Large |
| 8 | S4-1365 | Kuglen Iris Hook Push-Pull Model, Straight |
| 9 | S4-1387 | Sinskey li Lens Hook, 0.18mm Tip, Angled |
| 10 | S4-1455 | Castroviejo Caliper, Straight, 20mm |
| 11 | S4-1550 | Nagahara Horizontal Chopper |
| 12 | S5-1120 | Barraquer Colibri Forceps, 0.12mm With Tying Platform |
| 13 | S5-1240 | Bonn Forceps, 1X2 Teeth, 0.12mm, Long Model |
| 14 | S5-1365 | Bishop-Harmon Iris Forceps, 1X2 Teeth Standard, 0.8mm |
| 15 | S5-1603 | Utrata Capsulorhexis Forceps, Flat Handle |
| 16 | S5-1630 | Kelman-Mcpherson Tying Forceps, 8mm, Angled |
| 17 | S5-1650 | Mcpherson Tying Forceps, Long Model, Straight, With Platform |
| 18 | S5-1655 | Mcpherson Tying Forceps, Long Model, Angled, With Platform |
| 19 | S5-1794M | Livernois Lens Forceps, Modified |

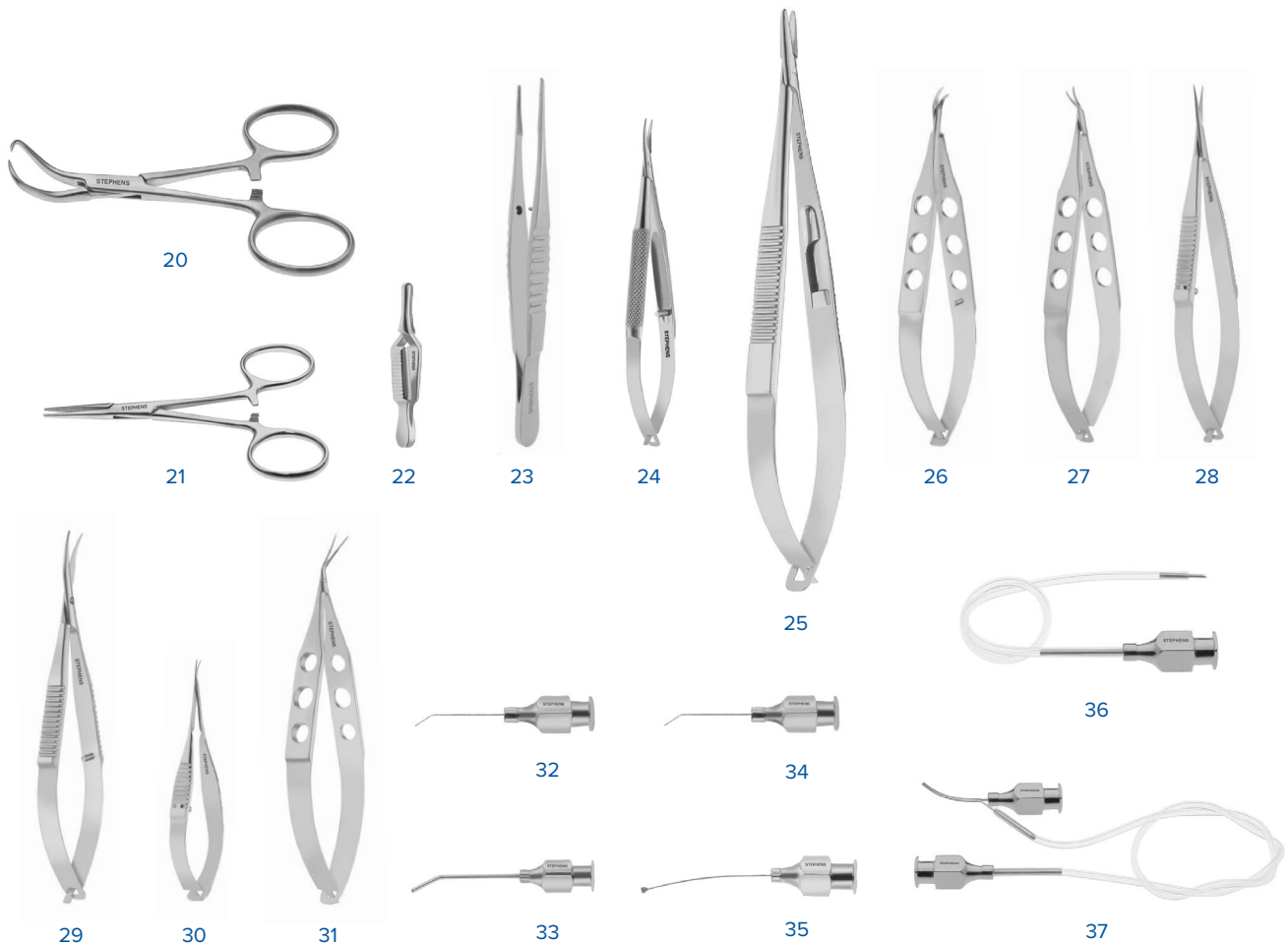

- 20 **S5-1904A** Backhaus Towel Clamp
- 21 **S5-1905** Mosquito Hemostat, 9cm, Straight
- 22 **S5-1925** Diffenbach Serrefine, 4cm, Straight
- 23 **S5-1960** Bonaccolto Utility Forceps, Delicate Model
- 24 **S6-1040** Barraquer Short Needle Holder, Curved, Without Lock, Delicate Jaw
- 25 **S6-1050** Castroviejo Needle Holder, Straight, With Lock, Standard Jaws
- 26 **S7-1165** Castroviejo Corneal Section Scissors, Small, Right
- 27 **S7-1170** Castroviejo Corneal Section Scissors, Small, Left
- 28 **S7-1315** Westcott Tenotomy Stitch Scissors, Standard Blades, Extra Sharp Tips
- 29 **S7-1325** Westcott Tenotomy Scissors, Standard Blades, Blunt
- 30 **S7-1375** Vannas Capsulotomy Scissors, Curved, Sharp
- 31 **S7-1384** Stern-Gills Vannas Scissors, 11mm Blades
- 32 **SC-1005** Bishop-Harmon Anterior Chamber Irrigator, Complete Set
- 33 **SC-1315** Healon Aspirating Cannula, Angled, 22ga
- 34 **SC-1630** Air Injection Cannula, Smooth Angled Tip, 27ga
- 35 **SC-1835** Jensen Post.Cap. Polisher, Sandblasted Tip, 23ga
- 36 **SC-1887** Stephens A/C Maintainer
- 37 **SC-1906** Simcoe Double Barrel I/A Cannula, 0.3mm Port, 23ga

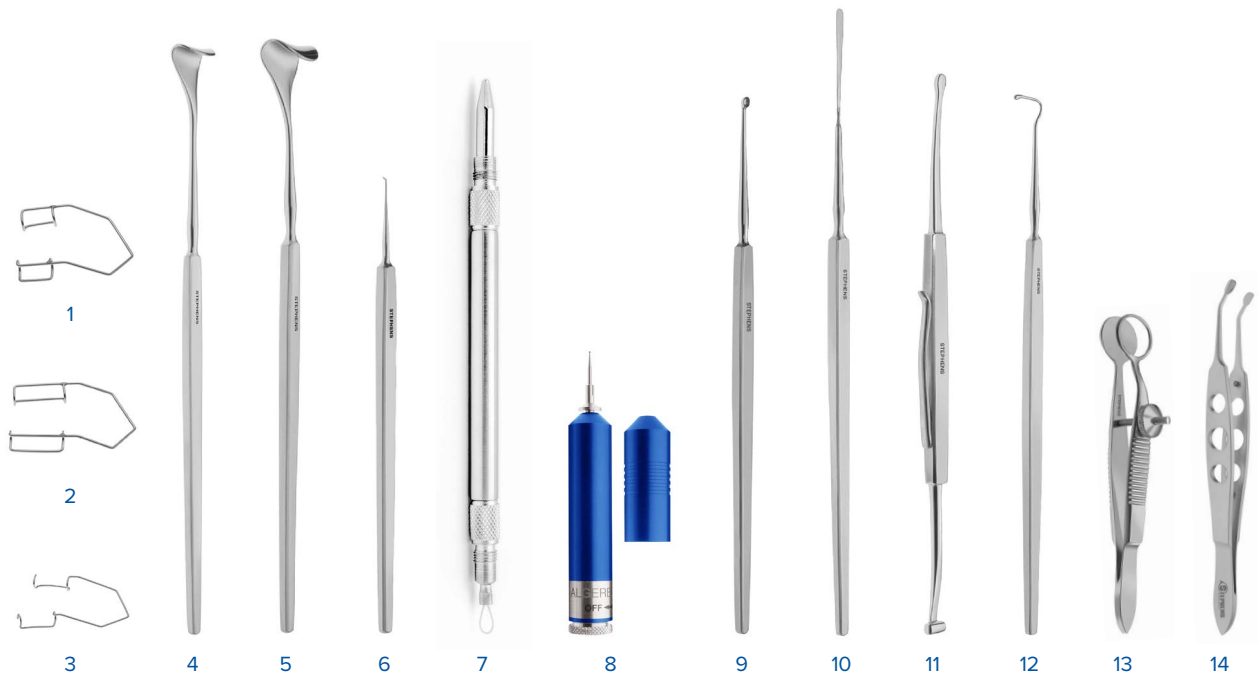

Office Set

- | | | |
|----|----------------|--|
| 1 | S1-1002 | Barraquer Wire Speculum, Child, 12mm |
| 2 | S1-1005 | Barraquer Wire Speculum, Adult, 15mm |
| 3 | S1-1016 | Kratz Wing Speculum, Without Bar, Adult |
| 4 | S1-1220 | Desmarres Lid Retractor #1, 13mm |
| 5 | S1-1225 | Desmarres Lid Retractor #2, 15mm |
| 6 | S2-1135 | Golf Club Foreign Body Spud |
| 7 | S2-1160 | Stephens Eye Loop & Magnet |
| 8 | S2-1170 | Alger Brush, Rust Ring Remover |
| 9 | S4-1015 | Meyerhoefer Chalazion Curette #3, 2.50mm |
| 10 | S4-1155 | Kimura Platinum Spatula |
| 11 | S4-1231 | Schocket Scleral Depressor, Double Ended |
| 12 | S4-1430 | Jameson Muscle Hook, Small |
| 13 | S5-1045 | Francis Chalazion Forceps, 12X14 Inside Diameter |
| 14 | S5-1058 | Stephens Meibomian Gland Expressor |

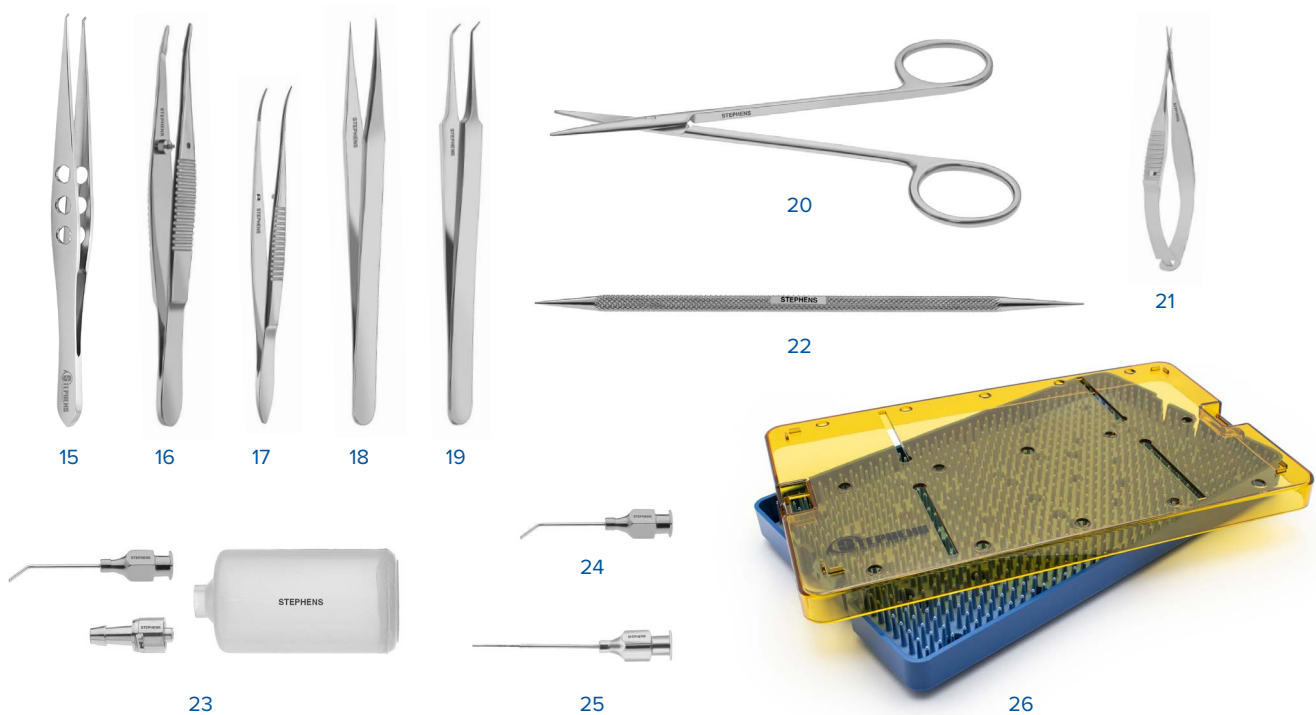

- 15 **S5-1059** Stephens Intra canalicular Plug Forceps
- 16 **S5-1085** Barraquer Cilia Forceps
- 17 **S5-1380** Dressing Forceps, With Guide Pin, Serrated, Curved
- 18 **S5-1700** Jewelers Forceps, #3C, Straight
- 19 **S5-1715** Jewelers Forceps, #5A, Angled
- 20 **S7-1110** Knapp Strabismus Scissors, Straight, Ring Handle
- 21 **S7-1370** Vannas Capsulotomy Scissors, Straight, Sharp
- 22 **S8-1015** Castroviejo Lacrimal Dilator, Medium & Fine Points
- 23 **SC-1005** Bishop-Harmon Anterior Chamber Irrigator, Complete Set
- 24 **SC-1020** Irrigation Cannula 19ga
- 25 **SC-1530** Lacrimal Cannula, Reinforced, 23ga Tip, Straight
- 26 **T1-0005** Plastic Instrument Tray, 6" x 10" x 0.75"

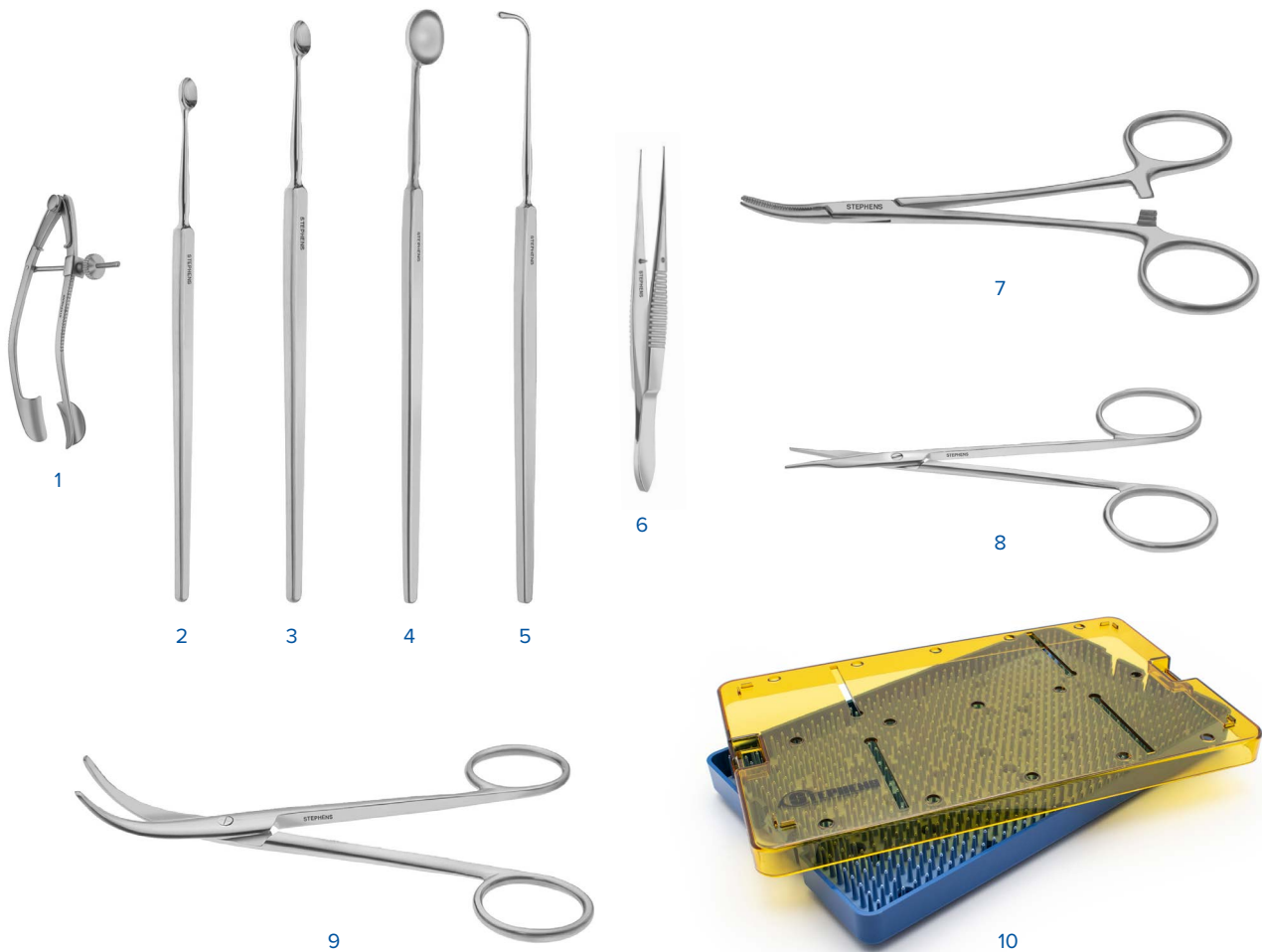

Enucleation Set

- | | | |
|----|----------------|--|
| 1 | S1-1070 | Lancaster Speculum, Solid Blades |
| 2 | S4-1200 | Bunge Evisceration Spoon, Small |
| 3 | S4-1205 | Bunge Evisceration Spoon, Medium |
| 4 | S4-1210 | Bunge Evisceration Spoon, Large |
| 5 | S4-1415 | Graefe Muscle Hook, Medium #2 |
| 6 | S5-1385 | Tissue Forceps, 1X2 Teeth, Straight |
| 7 | S5-1920 | Mosquito Hemostat, 12.5cm, Curved |
| 8 | S7-1085 | Stevens Tenotomy Scissors, Standard, Straight, Ring Handle |
| 9 | S7-1135 | Enucleation Scissors, Strong Curve, Ring Handle |
| 10 | T1-0005 | Plastic Instrument Tray, 6" x 10" x 0.75" |

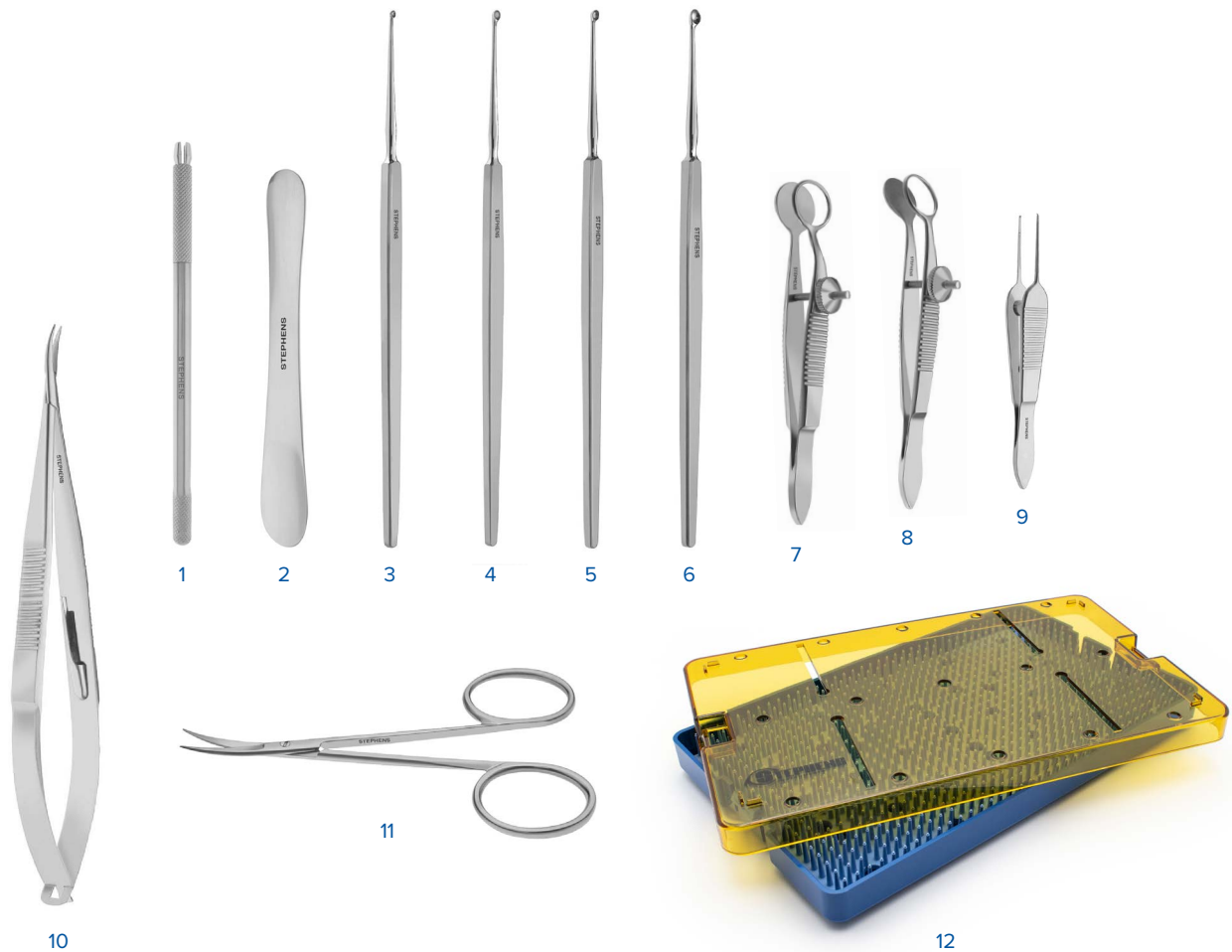

Chalazion

- 1 **AD-1036** Blade Handle, 3-Piece For Beaver
- 2 **S1-1235** Jaeger Lid Plate
- 3 **S4-1005** Meyerhoefer Chalazion Curette #1, 1.75mm
- 4 **S4-1010** Meyerhoefer Chalazion Curette #2, 2.25mm
- 5 **S4-1015** Meyerhoefer Chalazion Curette #3, 2.50mm
- 6 **S4-1020** Meyerhoefer Chalazion Curette #4, 3.50mm
- 7 **S5-1045** Francis Chalazion Forceps, 12X14 Inside Diameter
- 8 **S5-1055** Hunt Chalazion Forceps, 12mm Diameter
- 9 **S5-1668** Manhattan Eye & Ear Forceps
- 10 **S6-1075** Castroviejo Needle Holder, Curved, With Lock, Delicate Jaws
- 11 **S7-1040** Large Ring Scissors, Standard, Curved, Ring Handle
- 12 **T1-0005** Plastic Instrument Tray, 6" x 10" x 0.75"

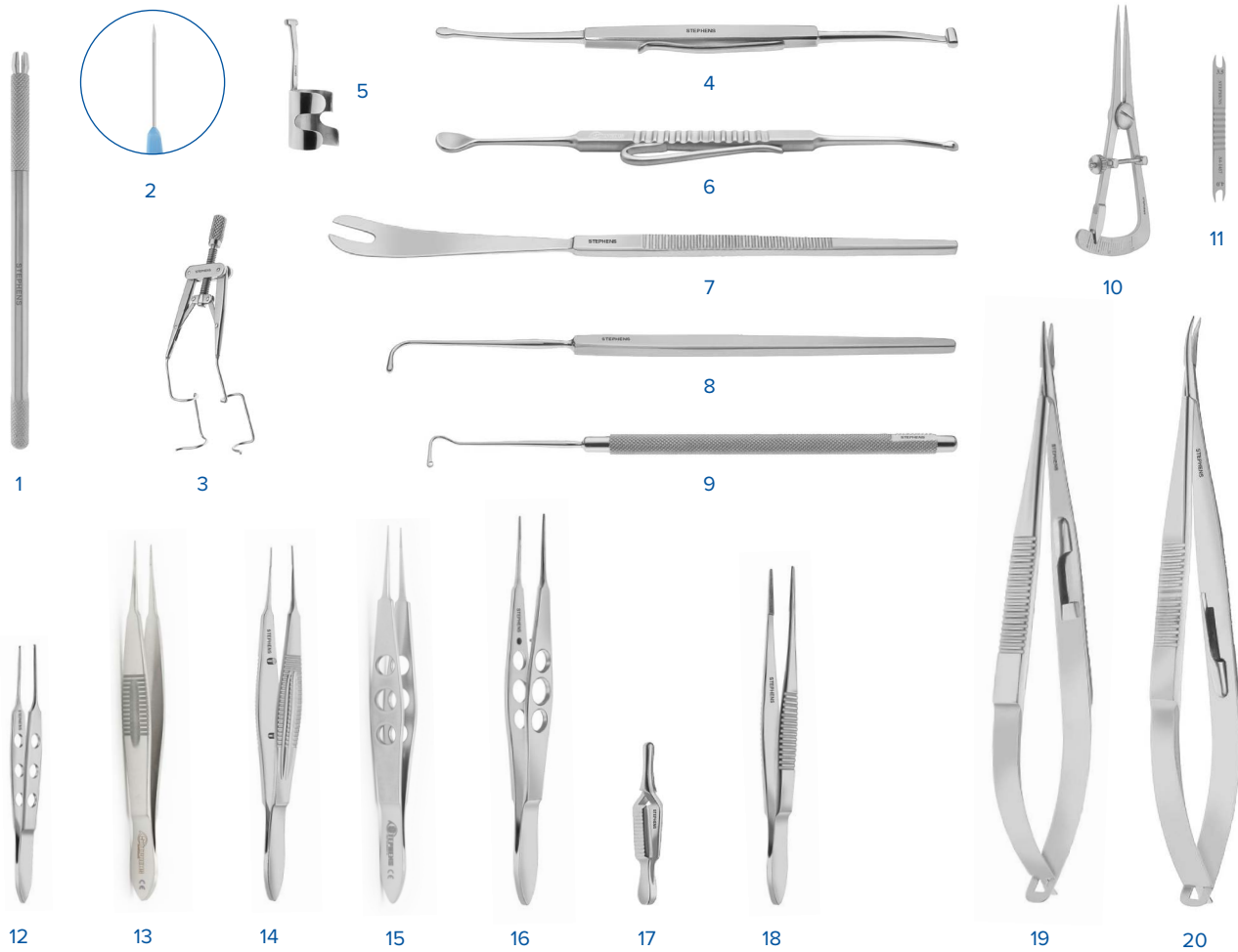

Vitreo Retinal 23ga

- | | | |
|----|----------------|---|
| 1 | AD-1036 | Blade Handle, 3-Piece For Beaver |
| 2 | R-5560 | 3.2mm Angle Slit Knife |
| 3 | S1-1026 | Lieberman Adjustable Eye Speculum, K-Shaped Wire |
| 4 | S4-1231 | Schocket Scleral Depressor, Double Ended |
| 5 | S4-1232 | Schepens Scleral Depressor, Thimble |
| 6 | S4-1236 | Josephberg-Besser Scleral Depressor, Double Ended |
| 7 | S4-1260 | Schepens Orbital Retractor |
| 8 | S4-1415 | Graefe Muscle Hook, Medium #2 |
| 9 | S4-1440 | Kirby Muscle Hook |
| 10 | S4-1455 | Castroviejo Caliper, Straight, 20mm |
| 11 | S4-1457 | Braunstein Caliper 3.5/4.0mm |
| 12 | S5-1365 | Bishop-Harmon Iris Forceps, 1X2 Teeth Standard, 0.8mm |
| 13 | S5-1560 | Castroviejo Suturing Forceps, 0.12mm, With Tying Platform |
| 14 | S5-1570 | Castroviejo Suturing Forceps, 0.3mm, With Tying Platform |
| 15 | S5-1650 | Mcperson Tying Forceps, Long Model, Straight, With Platform |
| 16 | S5-1895 | Bonaccolto Utility & Splinter Forceps, Serrated |
| 17 | S5-1925 | Diffenbach Serrefine, 4cm, Straight |

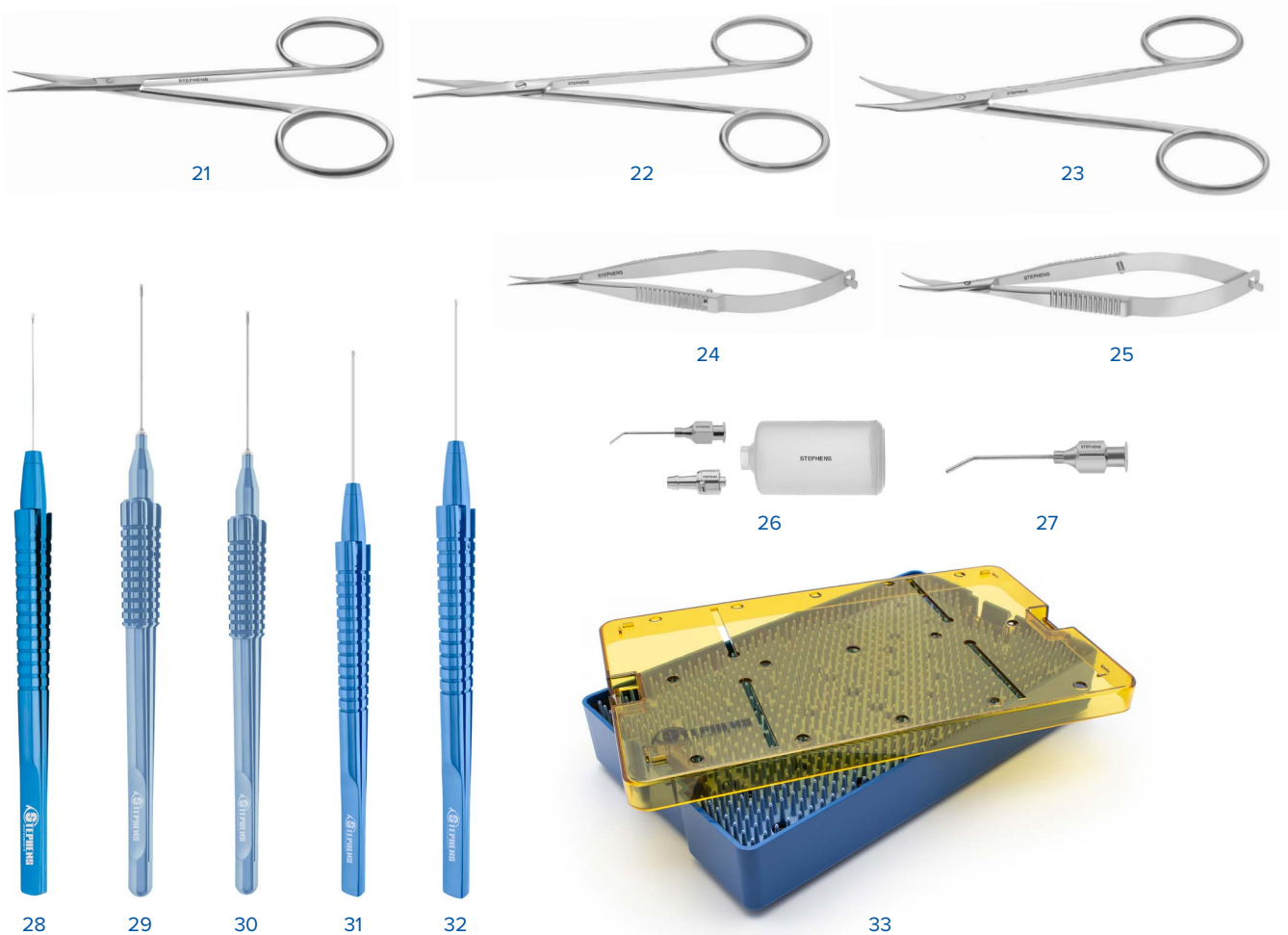

- 18 **S5-1955** Wills Hospital Utility Forceps, Serrated
- 19 **S6-1065** Castroviejo Needle Holder, Straight, With Lock, Delicate Jaws
- 20 **S6-1075** Castroviejo Needle Holder, Curved, With Lock, Delicate Jaws
- 21 **S7-1035** Large Ring Scissors, Standard, Straight
- 22 **S7-1085** Stevens Tenotomy Scissors, Standard, Straight, Ring Handle
- 23 **S7-1090** Stevens Tenotomy Scissors, Standard, Curved, Ring Handle
- 24 **S7-1315** Westcott Tenotomy Stitch Scissors, Standard Blades, Extra Sharp Tips
- 25 **S7-1325** Westcott Tenotomy Scissors, Standard Blades, Blunt
- 26 **SC-1005** Bishop-Harmon Anterior Chamber Irrigator, Complete Set
- 27 **SC-1315** Healon Aspirating Cannula, Angled, 22ga
- 28 **ST5-7000** Titanium Serrated Gripping Forceps, 1.5mm Tip, 23ga
- 29 **ST5-7005-23** Titanium Micro Gripping Forceps, 3mm Tip, 23ga
- 30 **ST5-7010-23** Titanium Micro Gripping Forceps, 1.2mm Tip, 23ga
- 31 **ST5-7050** Titanium Asymmetrical Forceps, 23ga
- 32 **ST5-7065** Titanium Ilm Peeling Forceps, 23ga
- 33 **T2-0005** Plastic Instrument Tray, 6" x 10" x 1.5" (Double Level)

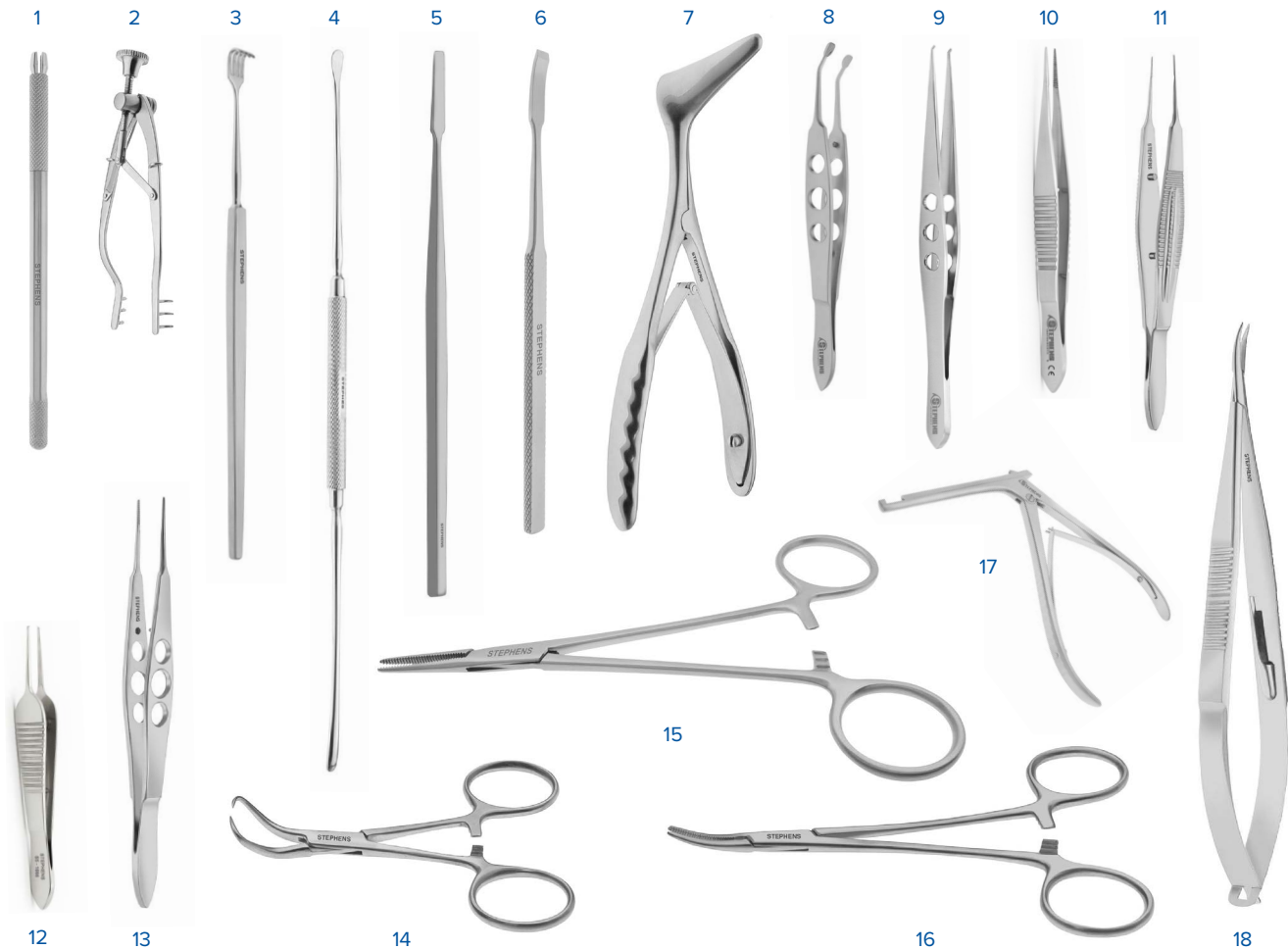

Lacrimal Set

- | | | |
|----|-----------------|---|
| 1 | AD-1036 | Blade Handle, 3-Piece For Beaver |
| 2 | S1-1255 | Stevenson Retractor, 3X3 Prongs |
| 3 | S1-1270 | Knapp Retractor, 4 Prongs, Blunt |
| 4 | S1-1275 | Tenzel Double Ended Periosteal Elevator |
| 5 | S1-1276 | West Lacrimal Chisel, Straight |
| 6 | S1-1277 | West Lacrimal Chisel, Curved |
| 7 | S1-1297 | Nasal Speculum, Adult |
| 8 | S5-1058 | Stephens Meibomian Gland Expressor |
| 9 | S5-1059 | Stephens Intracanalicular Plug Forceps |
| 10 | S5-1375 | Dressing Forceps, With Guide Pin, Serrated, Straight |
| 11 | S5-1570 | Castroviejo Suturing Forceps, 0.3mm, With Tying Platform |
| 12 | S5-1666 | Sauer Suture Forceps, 1X2, Oblique Angled |
| 13 | S5-1895 | Bonaccolto Utility & Splinter Forceps, Serrated |
| 14 | S5-1904A | Backhaus Towel Clamp |
| 15 | S5-1915 | Mosquito Hemostat, 12.5cm, Straight |
| 16 | S5-1920 | Mosquito Hemostat, 12.5cm, Curved |
| 17 | S5-1990 | Kerrison Rongeur Forceps, Size 1 |
| 18 | S6-1075 | Castroviejo Needle Holder, Curved, With Lock, Delicate Jaws |

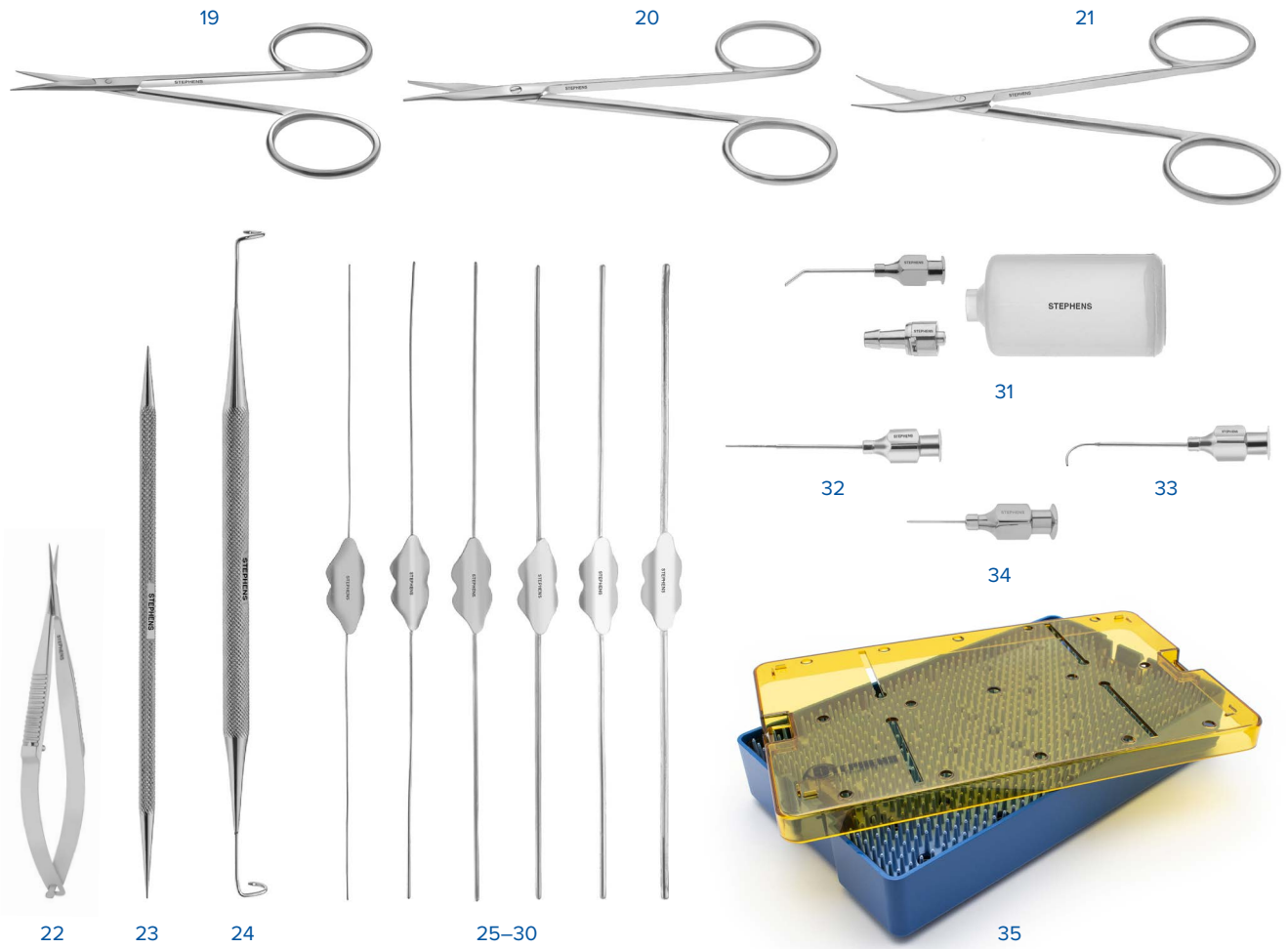

- 19 **S7-1035** Large Ring Scissors, Standard, Straight
- 20 **S7-1085** Stevens Tenotomy Scissors, Standard, Straight, Ring Handle
- 21 **S7-1090** Stevens Tenotomy Scissors, Standard, Curved, Ring Handle
- 22 **S7-1315** Westcott Tenotomy Stitch Scissors, Standard Blades, Extra Sharp Tips
- 23 **S8-1015** Castroviejo Lacrimal Dilator, Medium & Fine Points
- 24 **S8-1060** Pigtail Probe With Suture Holes
- 25 **S8-1065** Bowman Lacrimal Probe, Sterling Silver, 4/0-3/0
- 26 **S8-1070** Bowman Lacrimal Probe, Sterling Silver, 00-0
- 27 **S8-1075** Bowman Lacrimal Probe, Sterling Silver, 1-2
- 28 **S8-1080** Bowman Lacrimal Probe, Sterling Silver, 3-4
- 29 **S8-1085** Bowman Lacrimal Probe, Sterling Silver, 5-6
- 30 **S8-1090** Bowman Lacrimal Probe, Sterling Silver, 7-8
- 31 **SC-1005** Bishop-Harmon Anterior Chamber Irrigator, Complete Set
- 32 **SC-1530** Lacrimal Cannula, Reinforced, 23ga Tip, Straight
- 33 **SC-1535** Lacrimal Cannula, Reinforced, 23ga Tip, Curved
- 34 **SC-2005** Shahinian Cannula
- 35 **T2-0005** Plastic Instrument Tray, 6" x 10" x 1.5" (Double Level)

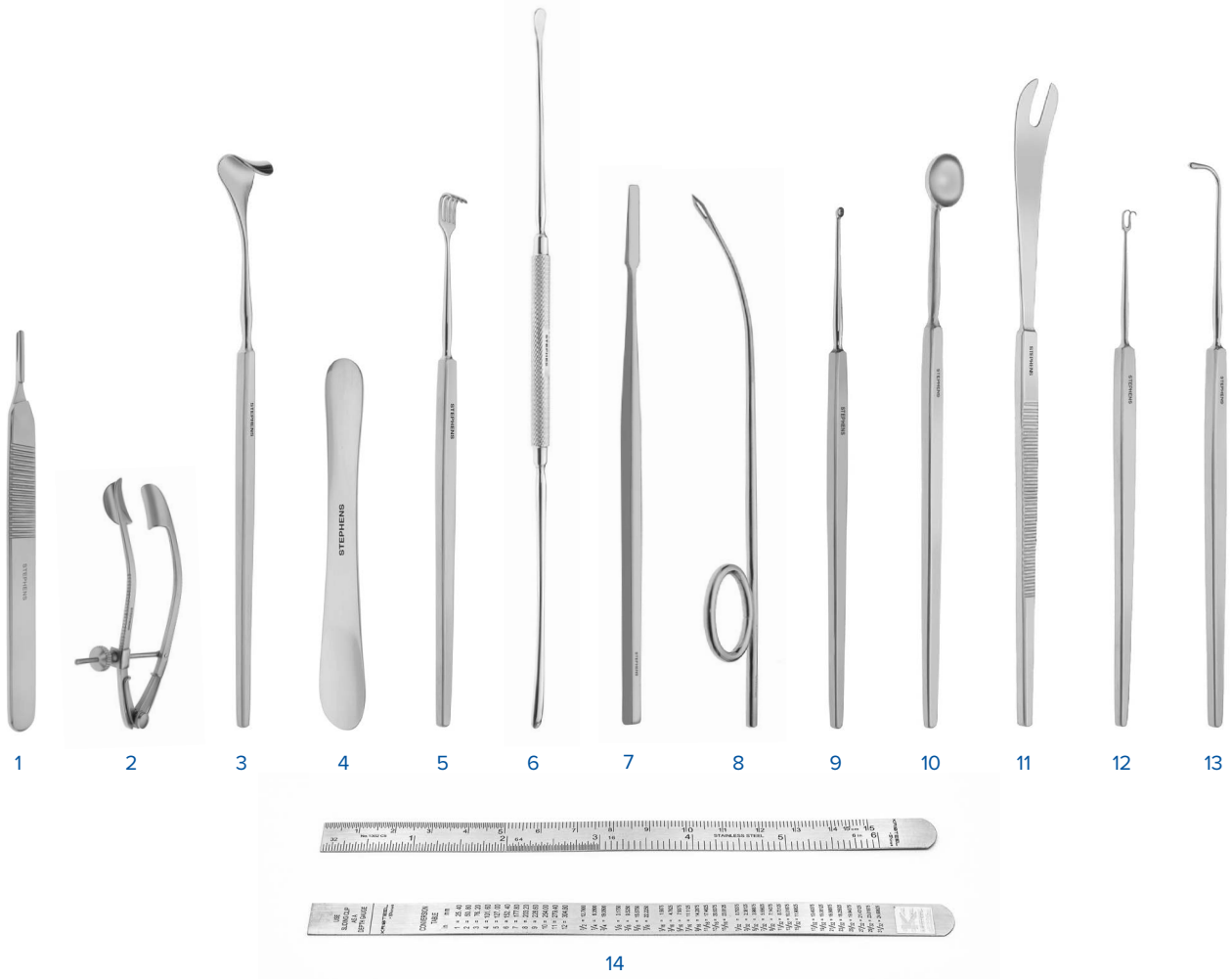

Oculoplastic

- | | | |
|----|----------------|--|
| 1 | AD-1000 | Blade Handle No. 3 |
| 2 | S1-1070 | Lancaster Speculum, Solid Blades |
| 3 | S1-1225 | Desmarres Lid Retractor #2, 15mm |
| 4 | S1-1235 | Jaeger Lid Plate |
| 5 | S1-1270 | Knapp Retractor, 4 Prongs, Blunt |
| 6 | S1-1275 | Tenzel Double Ended Periosteal Elevator |
| 7 | S1-1276 | West Lacrimal Chisel, Straight |
| 8 | S1-1310 | Wright Fascia Needle |
| 9 | S4-1015 | Meyerhoefer Chalazion Curette #3, 2.50mm |
| 10 | S4-1210 | Bunge Evisceration Spoon, Large |
| 11 | S4-1260 | Schepens Orbital Retractor |
| 12 | S4-1285 | Fixation Hook, Double Sharp, Large |
| 13 | S4-1415 | Graefe Muscle Hook, Medium #2 |
| 14 | S4-1490 | Ruler, Stainless Steel, 0.5mm Marking |

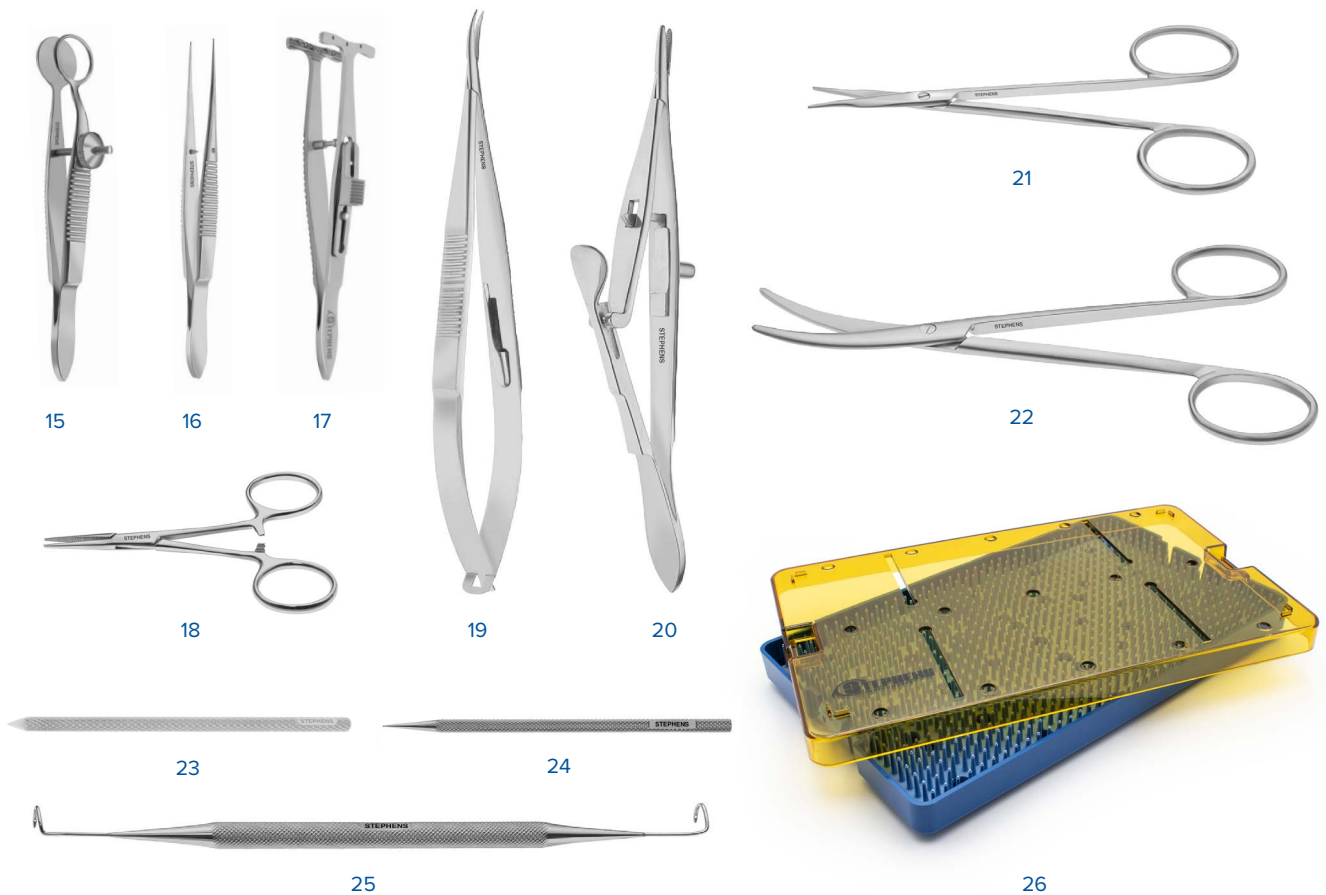

- 15 **S5-1045** Francis Chalazion Forceps, 12X14 Inside Diameter
- 16 **S5-1385** Tissue Forceps, 1X2 Teeth, Straight
- 17 **S5-1885** Putterman Muscle Conjunctival Clamp
- 18 **S5-1905** Mosquito Hemostat, 9cm, Straight
- 19 **S6-1075** Castroviejo Needle Holder, Curved, With Lock, Delicate Jaws
- 20 **S6-1110** Kalt Needle Holder, Straight
- 21 **S7-1085** Stevens Tenotomy Scissors, Standard, Straight, Ring Handle
- 22 **S7-1130** Enucleation Scissors
- 23 **S8-1035M** Naugle-Fleming Knurled Dilator, 3.5mm Diameter
- 24 **S8-1040** Wilder Lacrimal Dilator, Medium Taper
- 25 **S8-1060** Pigtail Probe With Suture Holes
- 26 **T1-0005** Plastic Instrument Tray, 6" x 10" x 0.75"



Lid Surgery

- | | | |
|----|----------------|--|
| 1 | AD-1036 | Blade Handle, 3-Piece For Beaver |
| 2 | S1-1220 | Desmarres Lid Retractor #1, 13mm |
| 3 | S1-1225 | Desmarres Lid Retractor #2, 15mm |
| 4 | S1-1230 | Desmarres Lid Retractor #3, 17mm |
| 5 | S1-1270 | Knapp Retractor, 4 Prongs, Blunt |
| 6 | S4-1280 | Fixation Hook, Double Sharp, Small |
| 7 | S4-1415 | Graefe Muscle Hook, Medium #2 |
| 8 | S4-1455 | Castroviejo Caliper, Straight, 20mm |
| 9 | S5-1015 | Berke Ptosis Forceps, 20mm |
| 10 | S5-1058 | Stephens Meibomian Gland Expressor |
| 11 | S5-1370 | Bishop-Harmon Iris Forceps, 1X2 Teeth Fine, 0.3mm |
| 12 | S5-1570 | Castroviejo Suturing Forceps, 0.3mm, With Tying Platform |
| 13 | S5-1680 | Paton Tying Forceps, With Platform, Sharp Points |
| 14 | S5-1885 | Putterman Muscle Conjunctival Clamp |
| 15 | S5-1895 | Bonaccolto Utility & Splinter Forceps, Serrated |

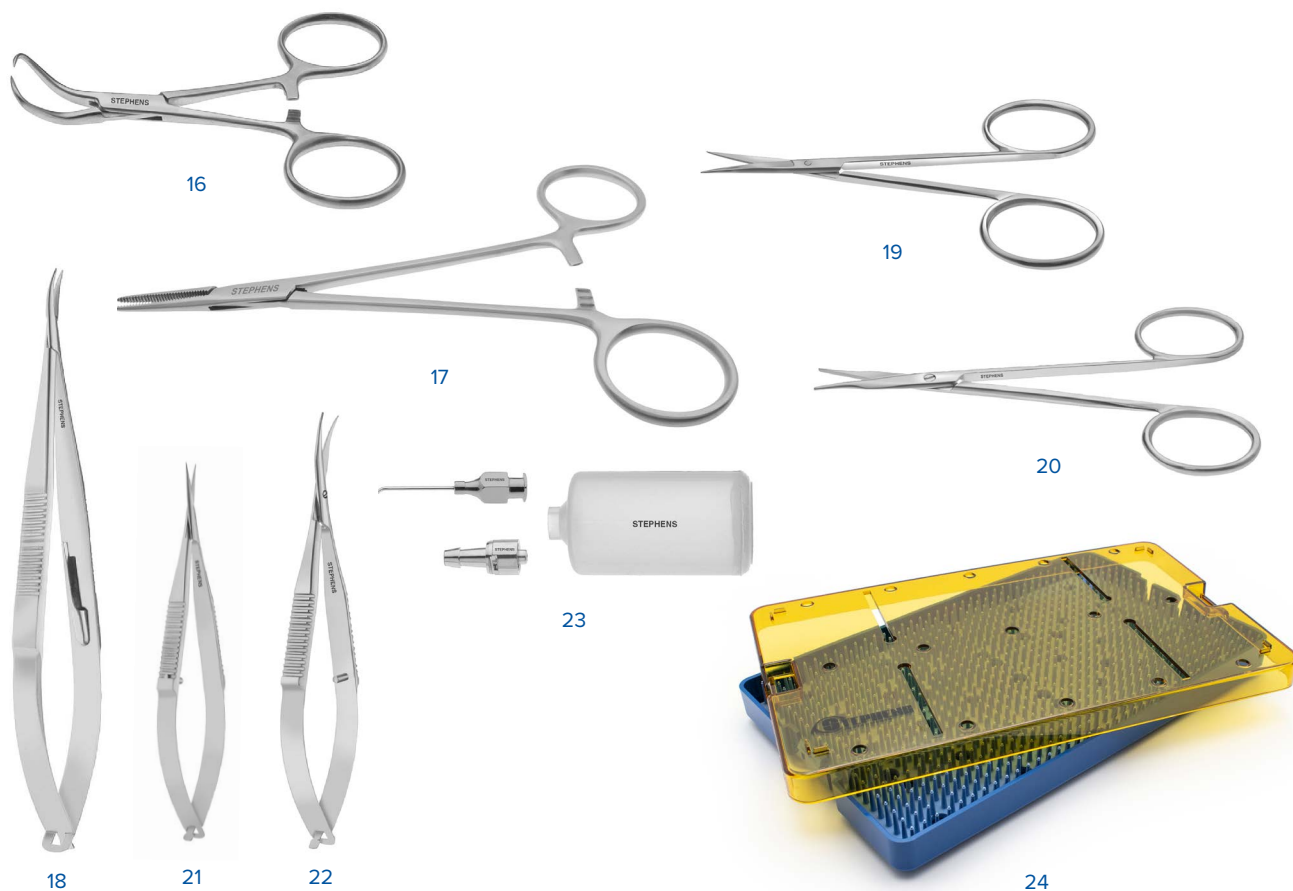

- 16 **S5-1904A** Backhaus Towel Clamp
- 17 **S5-1915** Mosquito Hemostat, 12.5cm, Straight
- 18 **S6-1075** Castroviejo Needle Holder, Curved, With Lock, Delicate Jaws
- 19 **S7-1035** Large Ring Scissors, Standard, Straight
- 20 **S7-1085** Stevens Tenotomy Scissors, Standard, Straight, Ring Handle
- 21 **S7-1315** Westcott Tenotomy Stitch Scissors, Standard Blades, Extra Sharp Tips
- 22 **S7-1325** Westcott Tenotomy Scissors, Standard Blades, Blunt
- 23 **SC-1005** Bishop-Harmon Anterior Chamber Irrigator, Complete Set
- 24 **T1-0005** Plastic Instrument Tray, 6" x 10" x 0.75"

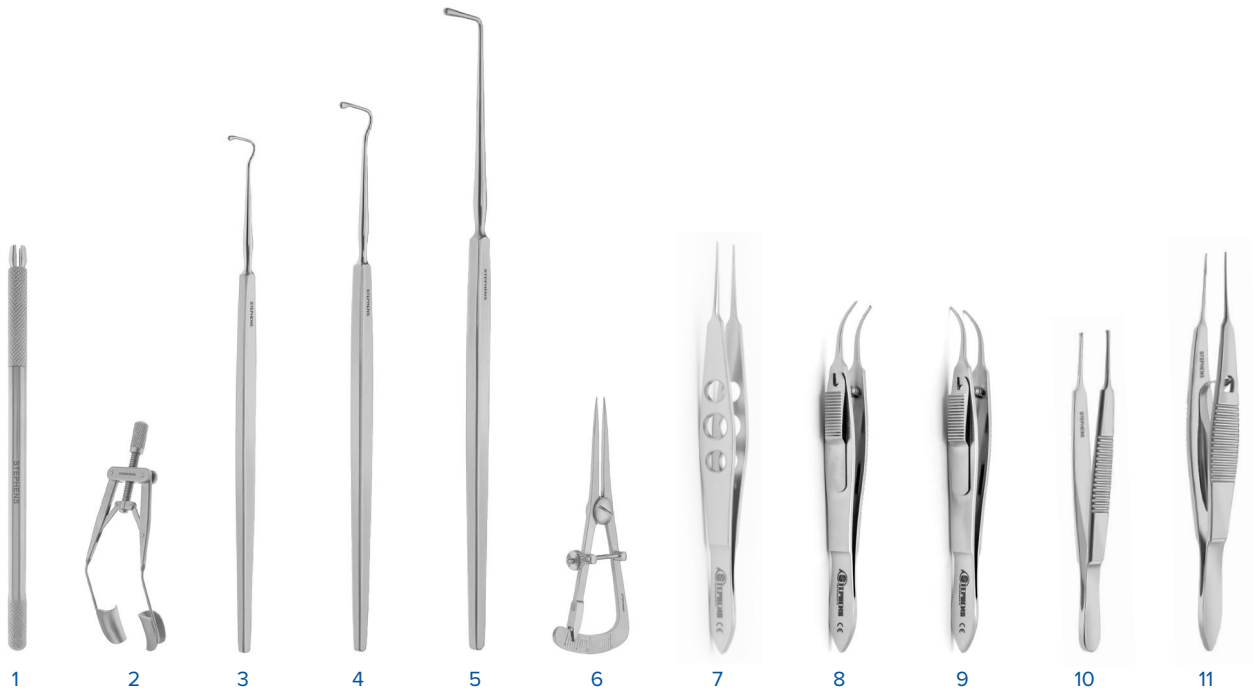

Strabismus

- | | | |
|----|----------------|--|
| 1 | AD-1036 | Blade Handle, 3-Piece For Beaver |
| 2 | S1-1028 | Lieberman Eye Speculum, Solid Blades |
| 3 | S4-1430 | Jameson Muscle Hook, Small |
| 4 | S4-1435 | Jameson Muscle Hook, Large |
| 5 | S4-1443 | Strabismus Hook, Extra Large |
| 6 | S4-1455 | Castroviejo Caliper, Straight, 20mm |
| 7 | S5-1240 | Bonn Forceps, 1X2 Teeth, 0.12mm, Long Model |
| 8 | S5-1410 | Moody Fixation Forceps, 0.5mm Teeth, Right |
| 9 | S5-1415 | Moody Fixation Forceps, 0.5mm Teeth, Left |
| 10 | S5-1440 | Lester Fixation Forceps, 9cm, 2X3 Teeth, 0.6mm |

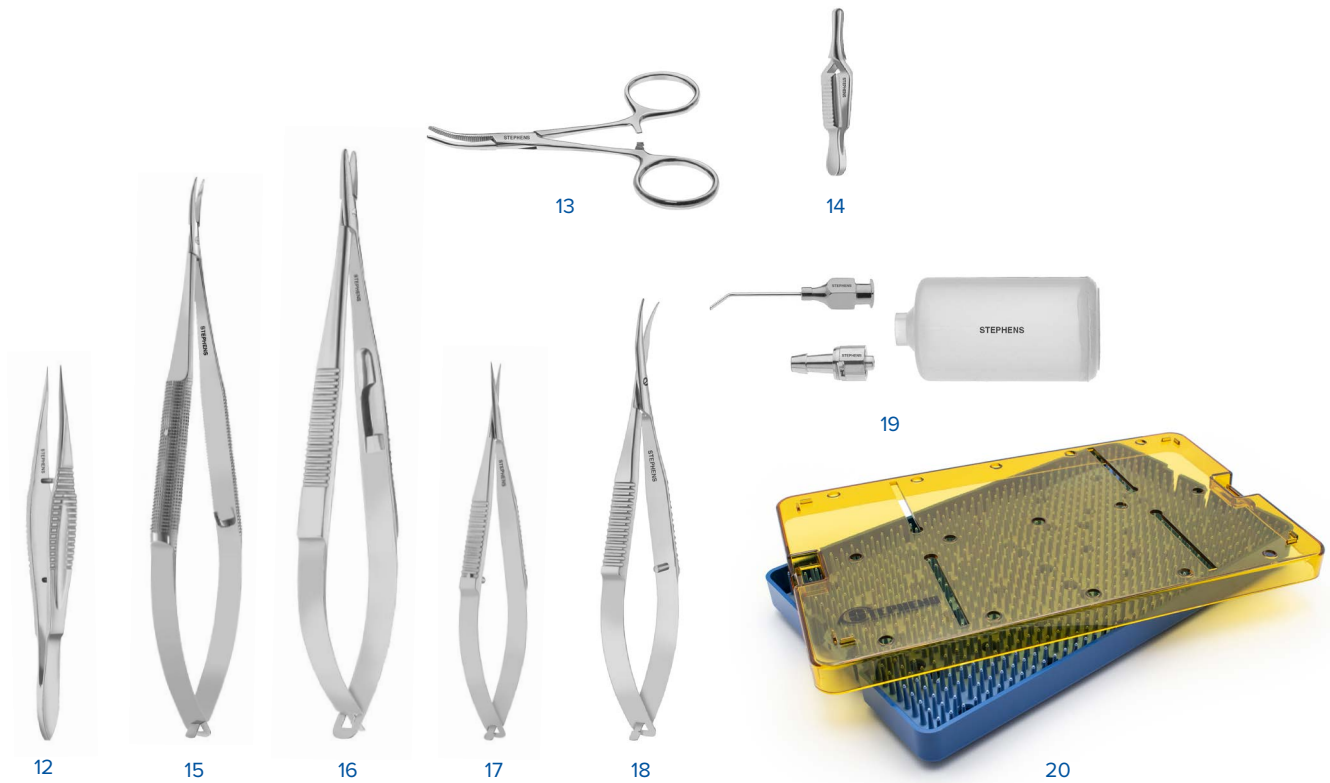

- 11 **S5-1576** Castroviejo Suturing Forceps, 0.5mm, With Tying Platform, With Lock
- 12 **S5-1680** Paton Tying Forceps, With Platform, Sharp Points
- 13 **S5-1910** Mosquito Hemostat, 9cm, Curved
- 14 **S5-1925** Diffenbach Serrefine, 4cm, Straight
- 15 **S6-1005** Barraquer Needle Holder, Curved, With Lock, Standard Jaws
- 16 **S6-1050** Castroviejo Needle Holder, Straight, With Lock, Standard Jaws
- 17 **S7-1315** Westcott Tenotomy Stitch Scissors, Standard Blades, Extra Sharp Tips
- 18 **S7-1325** Westcott Tenotomy Scissors, Standard Blades, Blunt
- 19 **SC-1005** Bishop-Harmon Anterior Chamber Irrigator, Complete Set
- 20 **T1-0005** Plastic Instrument Tray, 6" x 10" x 0.75"

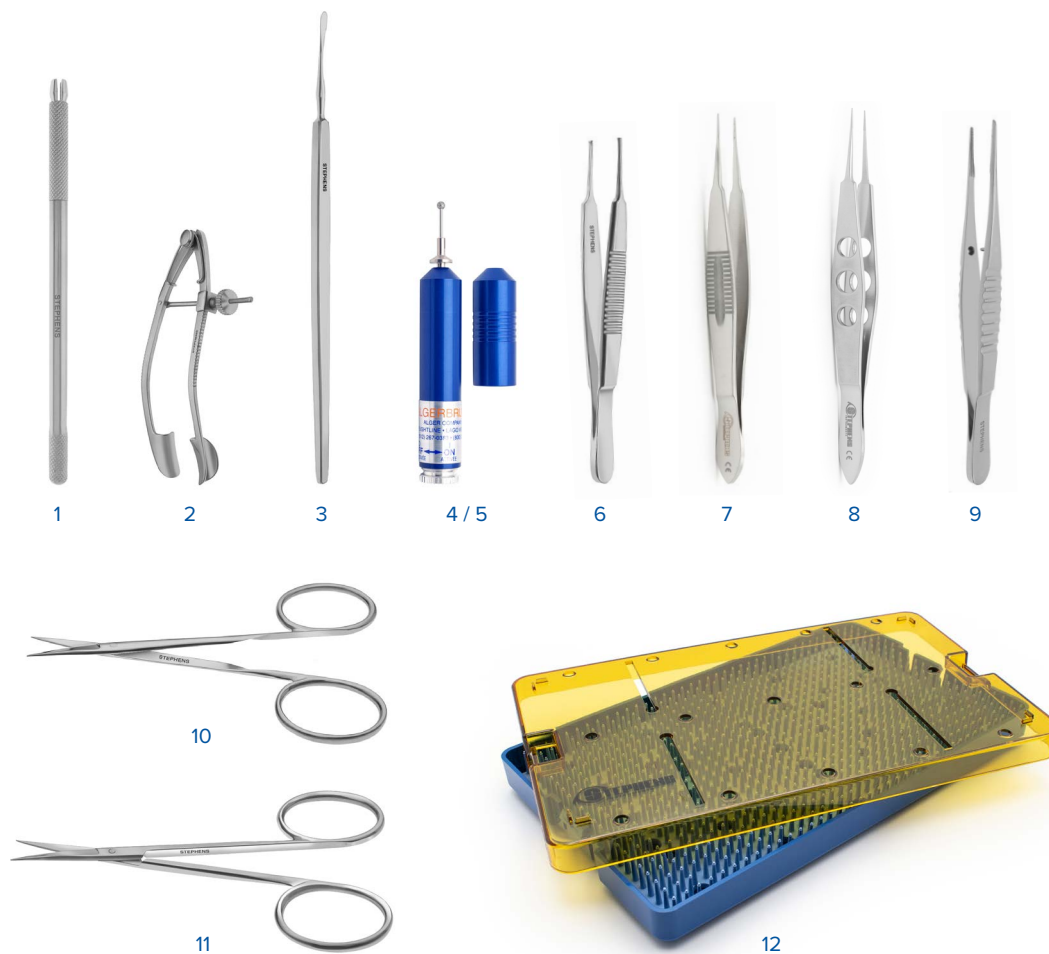

Pterygium Set

- | | | |
|----|----------------|---|
| 1 | AD-1036 | Blade Handle, 3-Piece For Beaver |
| 2 | S1-1070 | Barraquer Iris Spatula, Smooth, Round |
| 3 | S2-1115 | Gill Corneal Knife |
| 4 | S2-1176 | Pterygium Brush, 2.5mm Round Tip, Fine Grit, Diamond Dusted |
| 5 | S2-1179 | Chuck And Burr, For Pterygium Brush, 3.5mm Round Tip, Medium Grit, Diamond Dusted |
| 6 | S5-1440 | Lester Fixation Forceps, 9cm, 2X3 Teeth, 0.6mm |
| 7 | S5-1560 | Castroviejo Suturing Forceps, 0.12mm, With Tying Platform |
| 8 | S5-1650 | Mcperson Tying Forceps, Long Model, Straight, With Platform |
| 9 | S5-1960 | Bonaccolto Utility Forceps, Delicate Model |
| 10 | S7-1025 | Iris Scissors, Ribbon Type, Straight, Ring Handle |
| 11 | S7-1035 | Large Ring Scissors, Standard, Straight |
| 12 | T1-0005 | Plastic Instrument Tray, 6" x 10" x 0.75" |

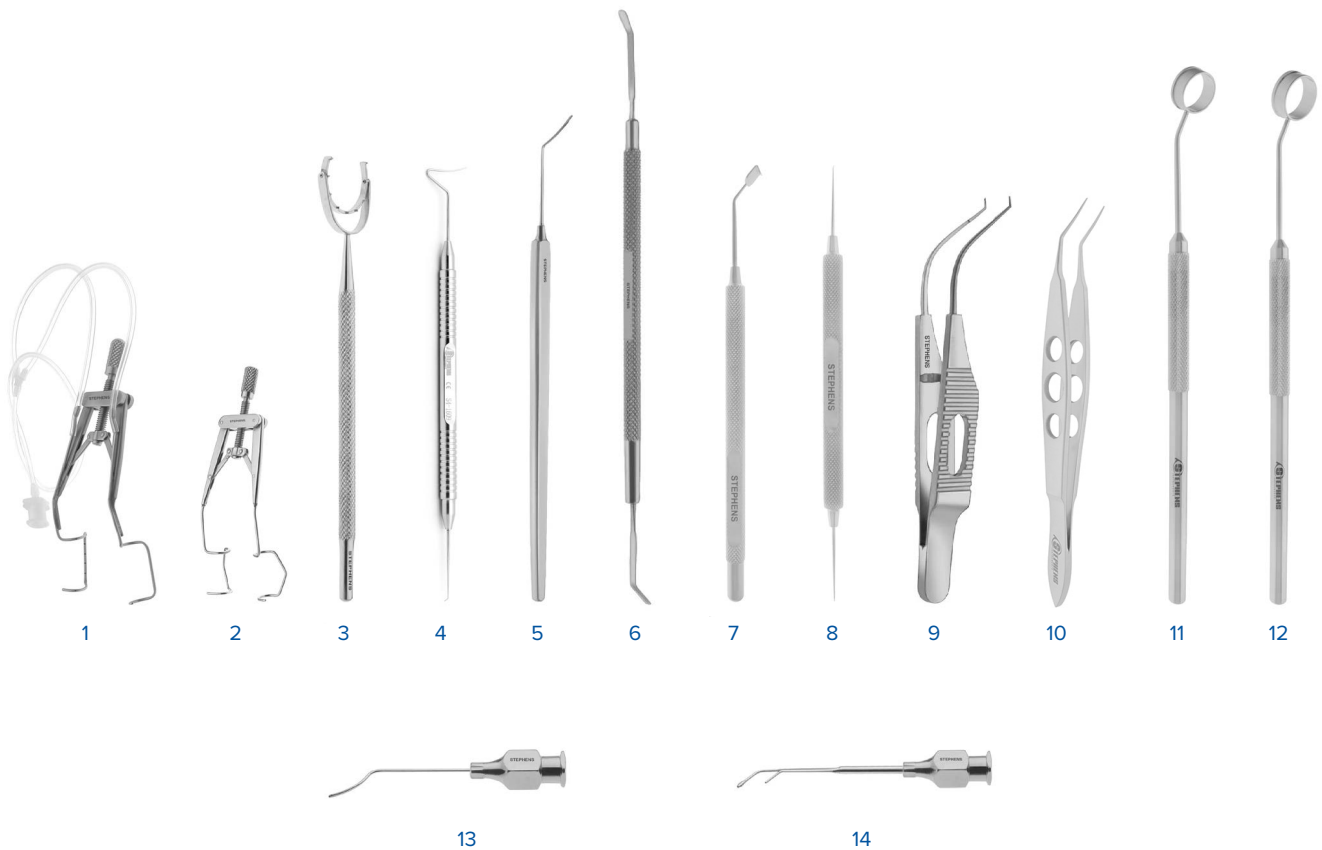

Lasik Set

- | | | |
|----|-----------------|--|
| 1 | S1-1025 | Stephens Irrigating Speculum |
| 2 | S1-1027 | Lieberman Adjustable Eye Speculum, V-Shaped Wire |
| 3 | S1-1211A | Thornton Fixation Ring, 12mm Swinging Handle, Open Ring 1/2 |
| 4 | S4-1609 | Seibel Intralase Separator/Elevator |
| 5 | S4-1615 | Slade Lasik Retreatment |
| 6 | S4-1620 | Herzing Lasik Elevator/Retractor |
| 7 | S4-1660 | Buratto Flap Protector |
| 8 | S4-1665 | Katzen Lasik Flap Unzipper |
| 9 | S5-1520 | Buratto Lasik Flap Forceps |
| 10 | S5-1525 | Mendez Lasik Flap Forceps |
| 11 | S9-1535 | Lasek Alcohol Well 8.5mm |
| 12 | S9-1536 | Lasek Alcohol Well 9.5mm |
| 13 | SC-5580 | Buratto Lasik Irrigation Cannula, 23ga, 3 Irrigation Holes, Angled |
| 14 | SC-5596 | Gulani, Tri Functional Lasik |

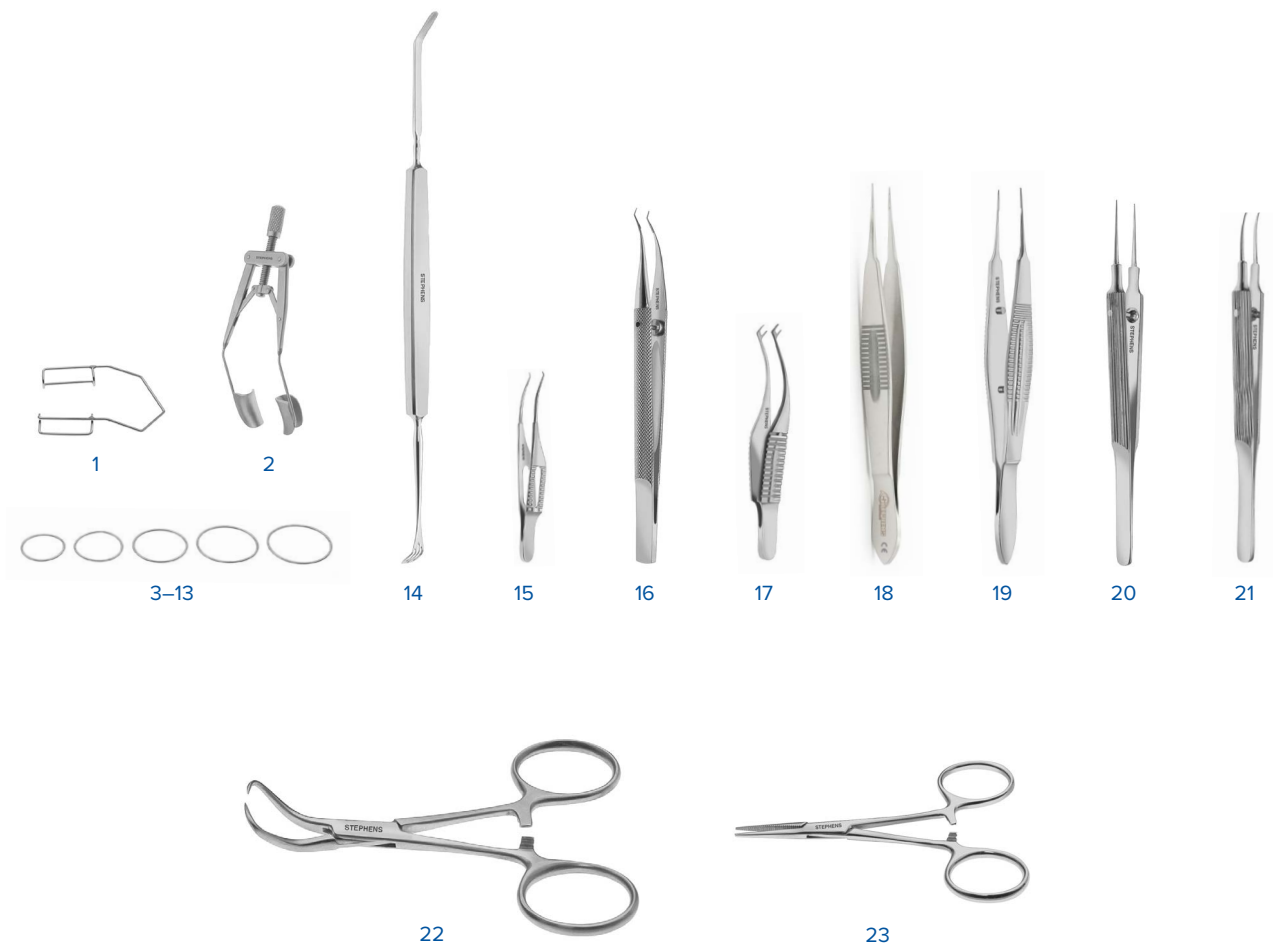

Corneal Transplant

- | | | |
|----|----------------|--|
| 1 | S1-1005 | Barraquer Wire Speculum, Adult, 15mm |
| 2 | S1-1028 | Lieberman Eye Speculum, Solid Blades |
| 3 | S1-1155 | Flieringa Fixation Ring, 12mm |
| 4 | S1-1160 | Flieringa Fixation Ring, 13mm |
| 5 | S1-1165 | Flieringa Fixation Ring, 14mm |
| 6 | S1-1170 | Flieringa Fixation Ring, 15mm |
| 7 | S1-1175 | Flieringa Fixation Ring, 16mm |
| 8 | S1-1180 | Flieringa Fixation Ring, 17mm |
| 9 | S1-1185 | Flieringa Fixation Ring, 18mm |
| 10 | S1-1190 | Flieringa Fixation Ring, 19mm |
| 11 | S1-1195 | Flieringa Fixation Ring, 20mm |
| 12 | S1-1200 | Flieringa Fixation Ring, 21mm |
| 13 | S1-1205 | Flieringa Fixation Ring, 22mm |
| 14 | S4-1154 | Paton Double Spatula, Angled, 2mm Tip |
| 15 | S5-1120 | Barraquer Colibri Forceps, 0.12mm With Tying Platform |
| 16 | S5-1140 | Colibri Forceps, 0.12mm, Round Handle |
| 17 | S5-1443 | Hoffer-Mcpherson Corneal Bi-Fixation Forceps, 0.12mm Teeth, 2 Sets Of 1X2, On A Gills Handle |
| 18 | S5-1560 | Castroviejo Suturing Forceps, 0.12mm, With Tying Platform |

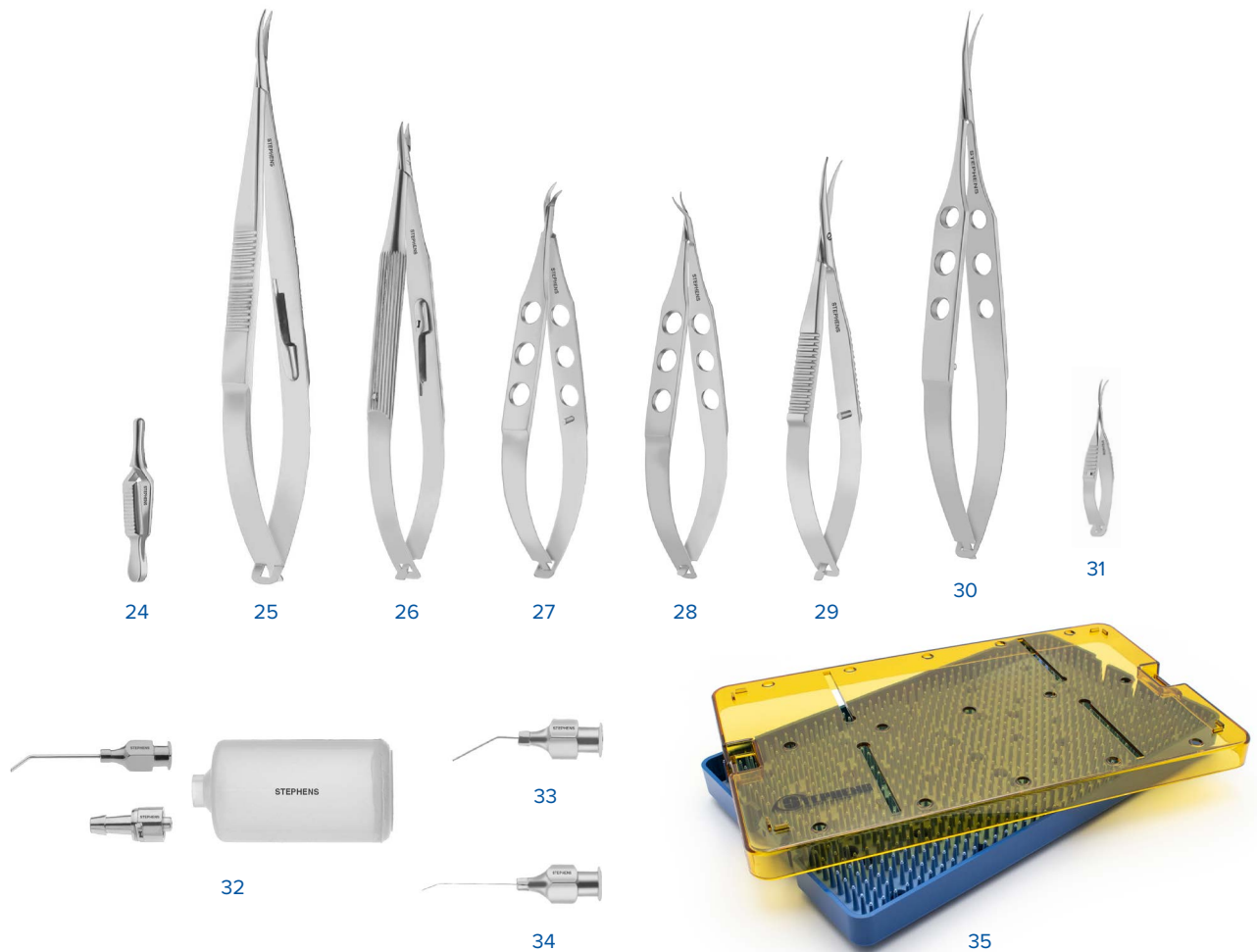

- 19 **S5-1570** Castroviejo Suturing Forceps, 0.3mm, With Tying Platform
- 20 **S5-1670** Tennant Tying Forceps, Round Hand, Straight, With Platform
- 21 **S5-1675** Tennant Tying Forceps, Round Hand, Curved, With Platform
- 22 **S5-1904A** Backhaus Towel Clamp
- 23 **S5-1905** Mosquito Hemostat, 9cm, Straight
- 24 **S5-1925** Diffenbach Serrefine, 4cm, Straight
- 25 **S6-1075** Castroviejo Needle Holder, Curved, With Lock, Delicate Jaws
- 26 **S6-1130** Stephens Needle Holder, Curved, With Lock, Very Delicate Jaws
- 27 **S7-1165** Castroviejo Corneal Section Scissors, Small, Right
- 28 **S7-1170** Castroviejo Corneal Section Scissors, Small, Left
- 29 **S7-1325** Westcott Tenotomy Scissors, Standard Blades, Blunt
- 30 **S7-1335** Jaffe Stitch Scissors, Extra Delicate, Very Sharp, Long
- 31 **S7-1389** Cohan-Vannas Scissors
- 32 **SC-1005** Bishop-Harmon Anterior Chamber Irrigator, Complete Set
- 33 **SC-1130** Anterior Chamber Cannula, 26ga, Angled
- 34 **SC-1625** Air Injection Cannula, Smooth Angled Tip, 30ga
- 35 **T1-0005** Plastic Instrument Tray, 6" x 10" x 0.75"

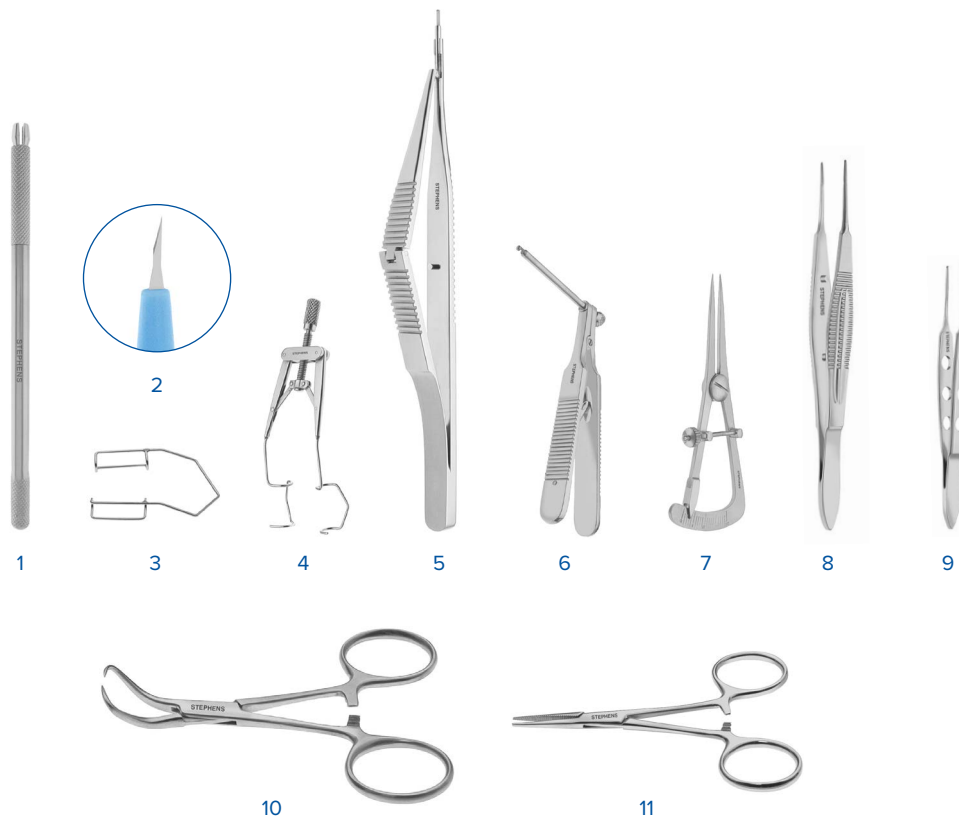

Glaucoma

- | | | |
|----|-----------------|--|
| 1 | AD-1036 | Blade Handle, 3-Piece For Beaver |
| 2 | R-1500 | 15 Degree Stab Knife |
| 3 | S1-1005 | Barraquer Wire Speculum, Adult, 15mm |
| 4 | S1-1027 | Lieberman Adjustable Eye Speculum, V-Shaped Wire |
| 5 | S3-1036 | Kelly Descemet Membrane Punch, 1.0mm |
| 6 | S3-1037 | Reiss Corneoscleral Punch, Rotating Tip |
| 7 | S4-1455 | Castroviejo Caliper, Straight, 20mm |
| 8 | S5-1355 | Macgregor Conjunctiva Forceps, 6mm Tying Platform, Serrated Tips |
| 9 | S5-1365 | Bishop-Harmon Iris Forceps, 1X2 Teeth Standard, 0.8mm |
| 10 | S5-1904A | Backhaus Towel Clamp |
| 11 | S5-1905 | Mosquito Hemostat, 9cm, Straight |

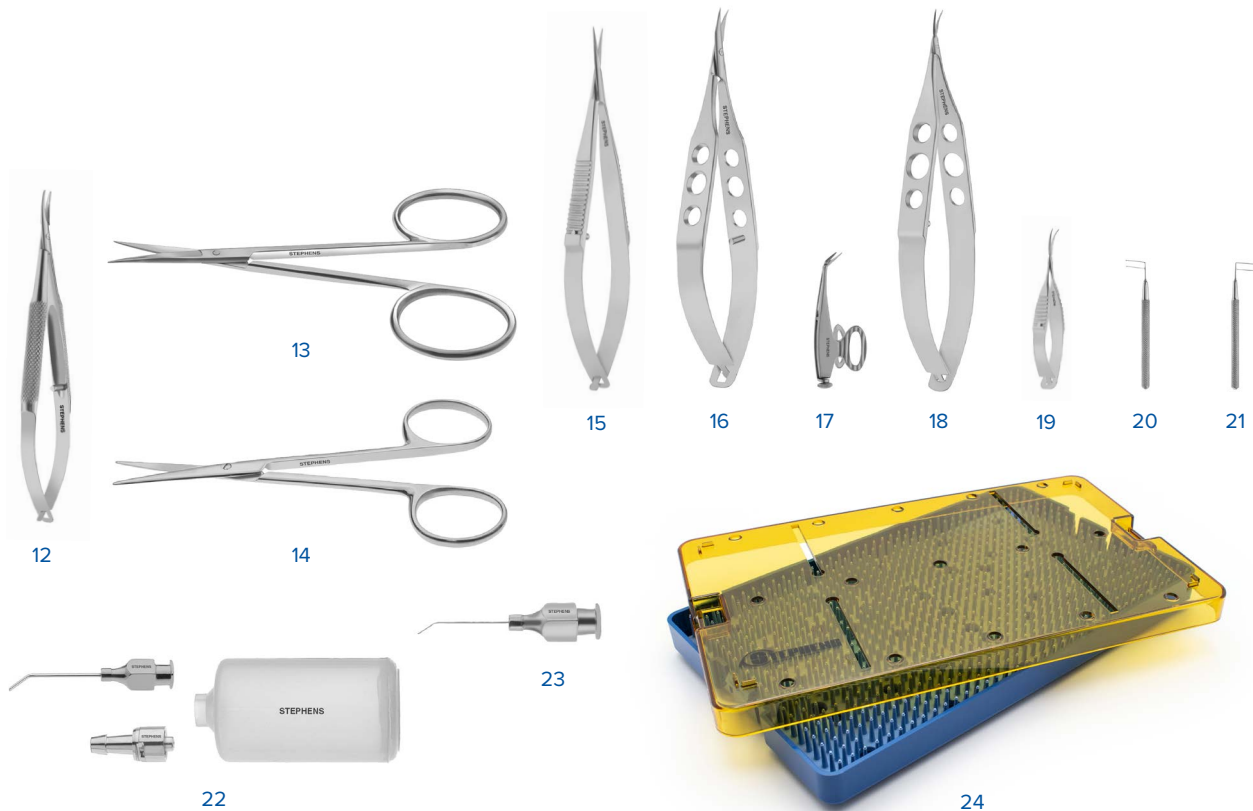

- 12 **S6-1040** Barraquer Short Needle Holder, Curved, Without Lock, Delicate Jaw
- 13 **S7-1035** Large Ring Scissors, Standard, Straight
- 14 **S7-1120** Knapp Strabismus Scissors, Ribbon, Straight, Ring Handle
- 15 **S7-1315** Westcott Tenotomy Stitch Scissors, Standard Blades, Extra Sharp Tips
- 16 **S7-1330** Mcpherson-Westcott Stitch Scissors, Small Blades, Extra Sharp
- 17 **S7-1360** Barraquer Iris Scissors, 7mm Blades
- 18 **S7-1367** Stephens-Vannas Scissors, 7mm Thin Blades, Curved
- 19 **S7-1389** Cohan-Vannas Scissors
- 20 **S8-1000** Harms Trabeculotomy Probe, Right
- 21 **S8-1005** Harms Trabeculotomy Probe, Left
- 22 **SC-1005** Bishop-Harmon Anterior Chamber Irrigator, Complete Set
- 23 **SC-1630** Air Injection Cannula, Smooth Angled Tip, 27ga
- 24 **T1-0005** Plastic Instrument Tray, 6" x 10" x 0.75"

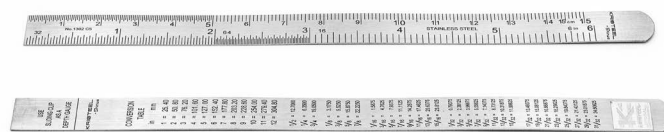
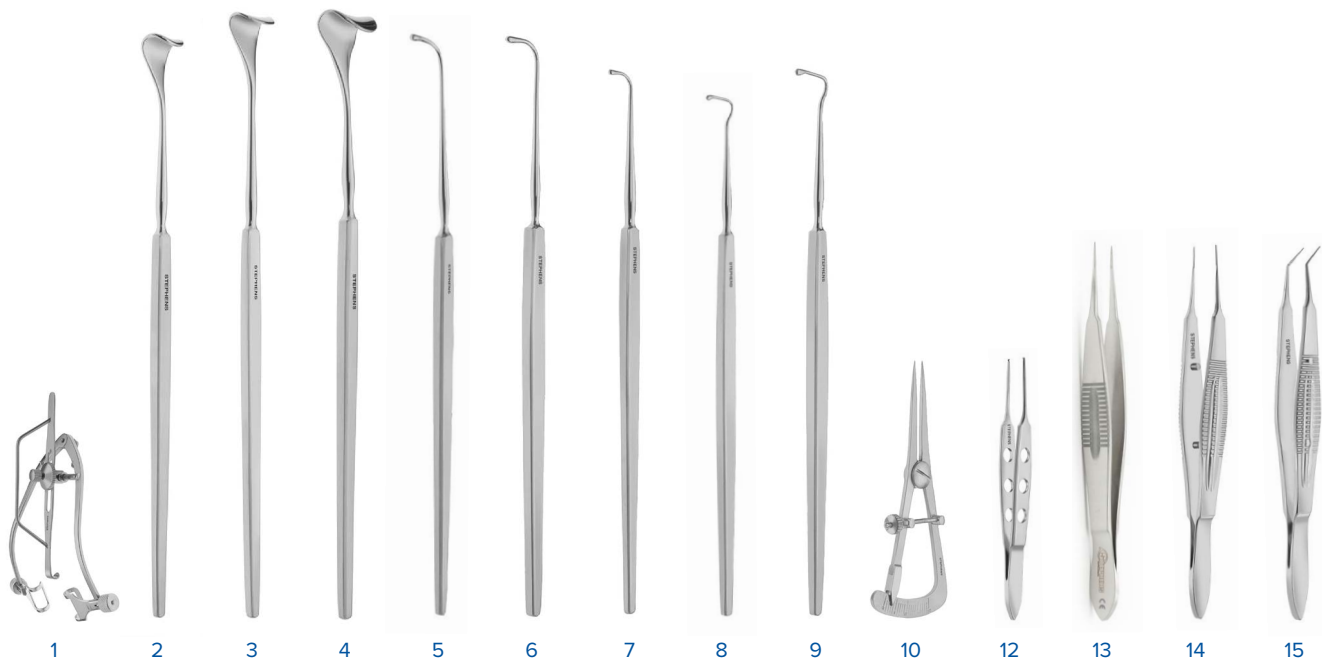

11

Muscle Set

- | | | |
|----|----------------|---|
| 1 | S1-1120 | Maumenee-Park Speculum, Fenestrated Blades |
| 2 | S1-1215 | Lieberman Eye Speculum, Solid Blades |
| 3 | S1-1220 | Desmarres Lid Retractor #1, 13mm |
| 4 | S1-1225 | Desmarres Lid Retractor #2, 15mm |
| 5 | S4-1410 | Graefe Muscle Hook, Large #3 |
| 6 | S4-1415 | Graefe Muscle Hook, Medium #2 |
| 7 | S4-1420 | Graefe Muscle Hook, Small #1 |
| 8 | S4-1430 | Jameson Muscle Hook, Small |
| 9 | S4-1435 | Jameson Muscle Hook, Large |
| 10 | S4-1455 | Castroviejo Caliper, Straight, 20mm |
| 11 | S4-1490 | Ruler, Stainless Steel, 0.5mm Marking |
| 12 | S5-1365 | Bishop-Harmon Iris Forceps, 1X2 Teeth Standard, 0.8mm |
| 13 | S5-1560 | Castroviejo Suturing Forceps, 0.12mm, With Tying Platform |
| 14 | S5-1570 | Castroviejo Suturing Forceps, 0.3mm, With Tying Platform |
| 15 | S5-1630 | Kelman-Mcpherson Tying Forceps, 8mm, Angled |

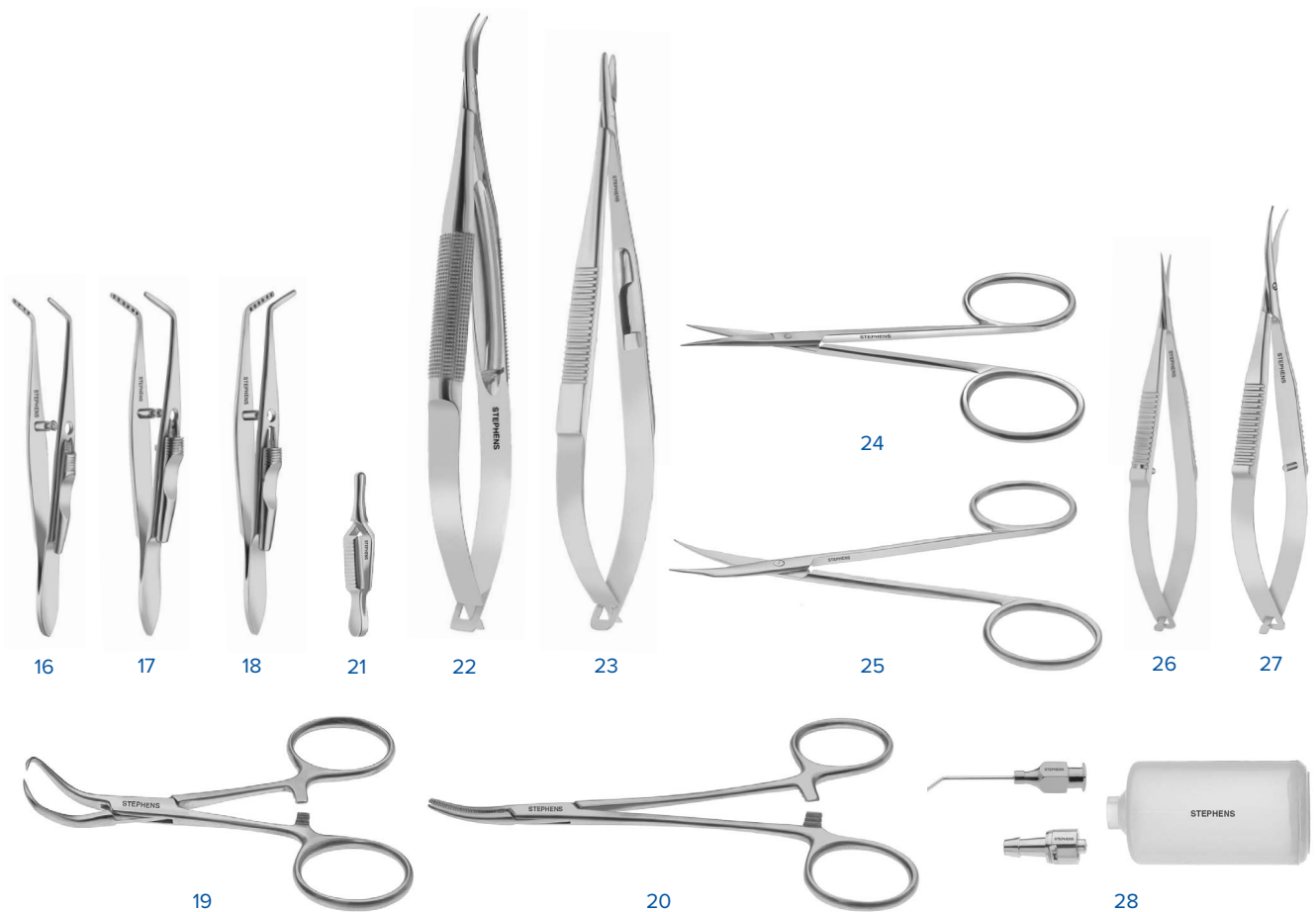

- 16 **S5-1850** Jameson Muscle Forceps, With Lock, Child, Left
- 17 **S5-1860** Jameson Muscle Forceps, With Lock, Adult, Left
- 18 **S5-1865** Jameson Muscle Forceps, With Lock, Adult, Right
- 19 **S5-1904A** Backhaus Towel Clamp
- 20 **S5-1920** Mosquito Hemostat, 12.5cm, Curved
- 21 **S5-1925** Diffenbach Serrefine, 4cm, Straight
- 22 **S6-1010** Barraquer Needle Holder, Curved, Without Lock, 0.5mm
- 23 **S6-1050** Castroviejo Needle Holder, Straight, With Lock, Standard Jaws
- 24 **S7-1035** Large Ring Scissors, Standard, Straight
- 25 **S7-1090** Stevens Tenotomy Scissors, Standard, Curved, Ring Handle
- 26 **S7-1315** Westcott Tenotomy Stitch Scissors, Standard Blades, Extra Sharp Tips
- 27 **S7-1325** Westcott Tenotomy Scissors, Standard Blades, Blunt
- 28 **SC-1005** Bishop-Harmon Anterior Chamber Irrigator, Complete Set

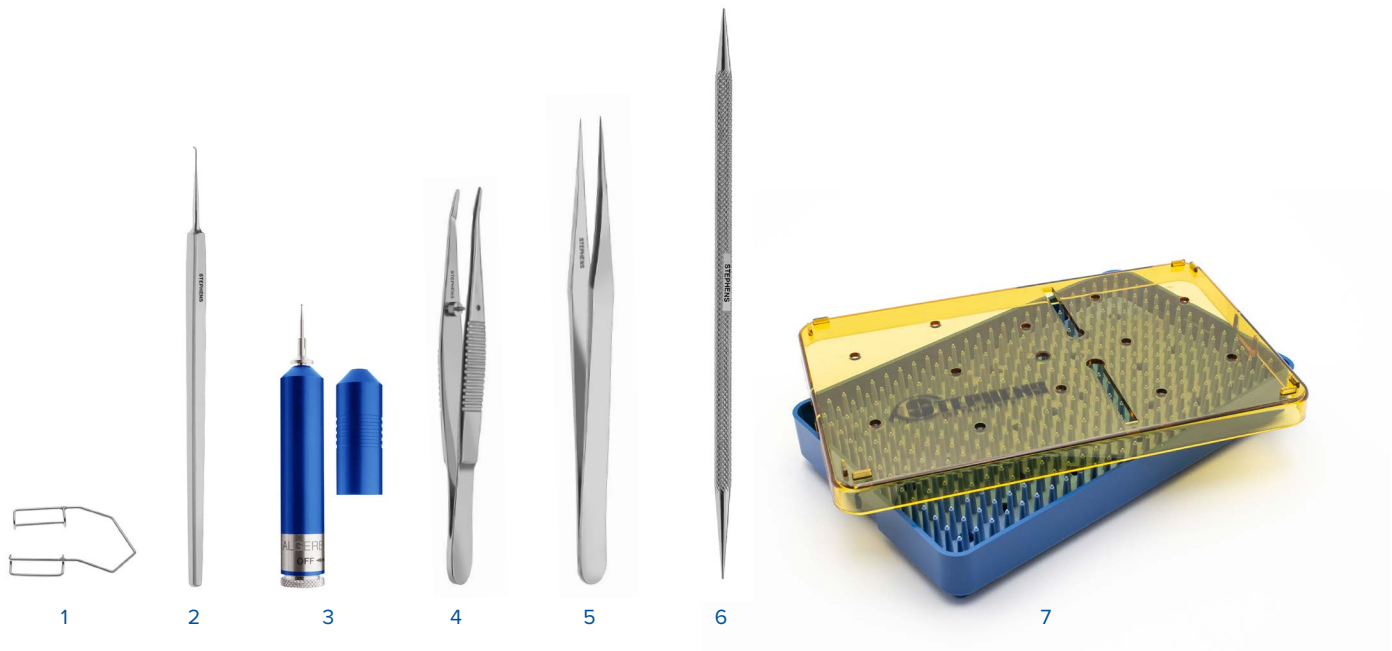

Foreign Body

- | | | |
|---|----------------|--|
| 1 | S1-1005 | Barraquer Wire Speculum, Adult, 15mm |
| 2 | S2-1135 | Golf Club Foreign Body Spud |
| 3 | S2-1170 | Alger Brush, Rust Ring Remover |
| 4 | S5-1085 | Barraquer Cilia Forceps |
| 5 | S5-1690 | Jewelers Forceps, #1, Straight |
| 6 | S8-1015 | Castroviejo Lacrimal Dilator, Medium & Fine Points |
| 7 | T1-0003 | Plastic Instrument Tray, 4" x 6.5" x 0.75" |

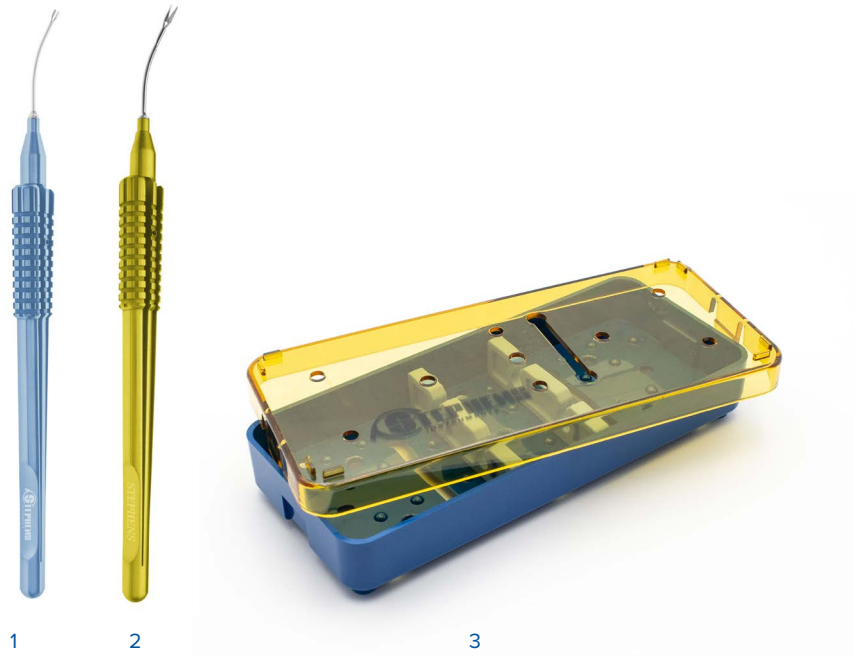

IOL Removal

- 1 **ST5-7070** Titanium Iol Holding Forceps, Grooved Jaws, 20ga
- 2 **ST7-1410** Titanium Iol Cutting Scissors, 18ga
- 3 **T1-0007** Plastic Instrument Tray, 2.5" x 6" x 0.75" (Silicone Bars)

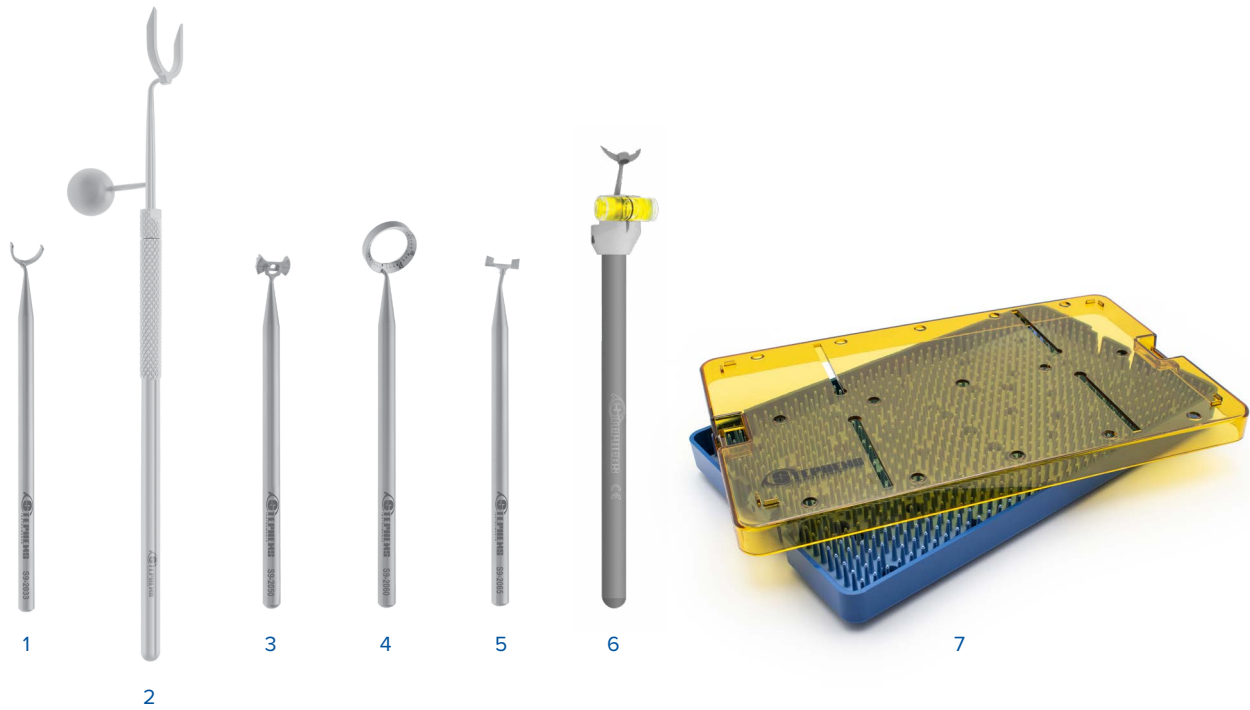

Toric IOL

- | | | |
|---|----------------|--|
| 1 | S9-2033 | Henderson Pre Operative Alignment Marker |
| 2 | S9-2040 | Lri Gravity Marker, 12.5mm At 3 & 9 |
| 3 | S9-2050 | Henderson 30, 45, 60 Degree Lri Axis Marker |
| 4 | S9-2060 | Henderson Degree Gauge |
| 5 | S9-2065 | Henderson Toric Iol Marker |
| 6 | S9-2070 | Stephens Toric Iol Marker, With Bubble Level |
| 7 | T1-0005 | Plastic Instrument Tray, 6" x 10" x 0.75" |

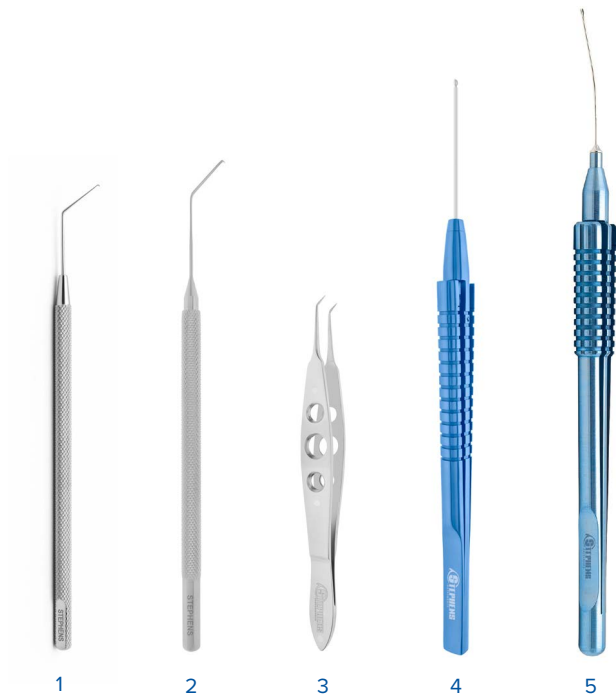

DSEK / DMEK

- | | | |
|---|-----------------|--|
| 1 | S4-1397 | Reverse Sinskey Hook For Dsek |
| 2 | S4-1670 | Endothelial Stripper |
| 3 | S5-1655M | Dmek Tissue Prep Forceps, 2.5mm Platform |
| 4 | ST5-7056 | Titanium Asymmetrical Forceps, 25ga |
| 5 | ST5-7060 | Titanium Dsaek Corneal Forceps, 23ga |



LACRIVERA[®]

A Stephens Instruments Company

Dry Eye Management

Silicone Plugs	176
Temporary Plugs	182
Ancillaries	186

VeraPlug™
FlexFit™
Punctal Occlusion System



The VeraPlug™ FlexFit™ is designed for **simple sizing, easy insertion, patient comfort, and retention**—providing a proven treatment for chronic dry eye.

- Two sizes fit most patients for **simple sizing**
- FlexFit™ nose design provides **easy insertion** and **superior retention**
- Low-profile dome for excellent **patient comfort**



VeraPlug FlexFit Sterile Preloaded

Individually packaged and preloaded on a sterile, disposable inserter. 1 pair per box.

SKU		SIZE
VFF-5000	VeraPlug FlexFit Sterile Preloaded - X-Small	0.2mm to 0.3mm
VFF-5001	VeraPlug FlexFit Sterile Preloaded - Small	0.3mm to 0.5mm
VFF-5002	VeraPlug FlexFit Sterile Preloaded - Medium	0.6mm to 0.8mm
VFF-5003	VeraPlug FlexFit Sterile Preloaded - Large	0.9mm to 1.0mm

VeraPlug FlexFit Bulk Nonsterile

Packaged nonsterile, 1 pair per poly bag. 10 pairs per box. Inserters included.

SKU		SIZE
BFF-5000	VeraPlug FlexFit Nonsterile Bulk - X-Small	0.2mm to 0.3mm
BFF-5001	VeraPlug FlexFit Nonsterile Bulk - Small	0.3mm to 0.5mm
BFF-5002	VeraPlug FlexFit Nonsterile Bulk - Medium	0.6mm to 0.8mm
BFF-5003	VeraPlug FlexFit Nonsterile Bulk - Large	0.9mm to 1.0mm

VeraPlug™

Punctal Occlusion System

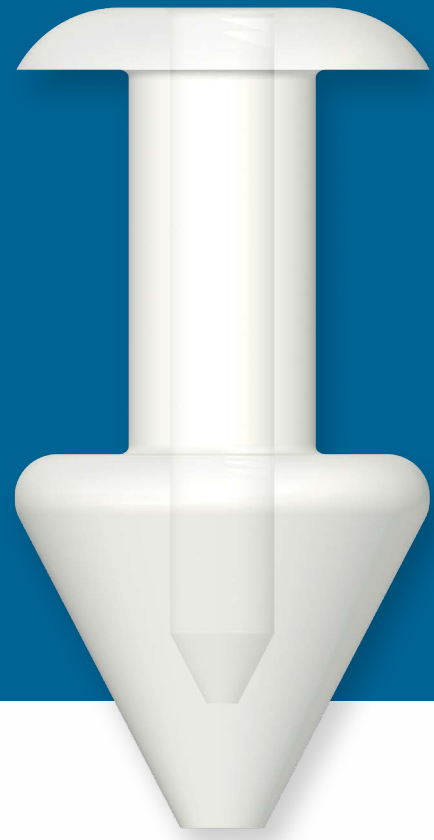

The **VeraPlug™** is designed to provide a simple and effective treatment for chronic dry eye.

- Engineered to perfectly fit the puncta for **excellent retention**
- Low-profile dome for **enhanced patient comfort**
- Proprietary shaft design for **easy insertion** and **proper anatomic fit**
- Available in four sizes



VeraPlug Sterile Preloaded

Individually packaged and preloaded on a sterile, disposable inserter. 1 pair per box.

SKU		SIZE
VSP-1001	VeraPlug Sterile Preloaded - Small	0.4mm to 0.6mm
VSP-1002	VeraPlug Sterile Preloaded - Medium	0.6mm to 0.7mm
VSP-1003	VeraPlug Sterile Preloaded - Large	0.7mm to 0.8mm
VSP-1004	VeraPlug Sterile Preloaded - X-Large	0.8mm to 1.0mm

VeraPlug Bulk Nonsterile

Packaged nonsterile, 1 pair per poly bag, 10 pairs per box. Inserters included.

SKU		SIZE
BNS-1001	VeraPlug Nonsterile Bulk - Small	0.4mm to 0.6mm
BNS-1002	VeraPlug Nonsterile Bulk - Medium	0.6mm to 0.7mm
BNS-1003	VeraPlug Nonsterile Bulk - Large	0.7mm to 0.8mm
BNS-1004	VeraPlug Nonsterile Bulk - X-Large	0.8mm to 1.0mm

VeraPlug™ *flow*

Punctal Occlusion System

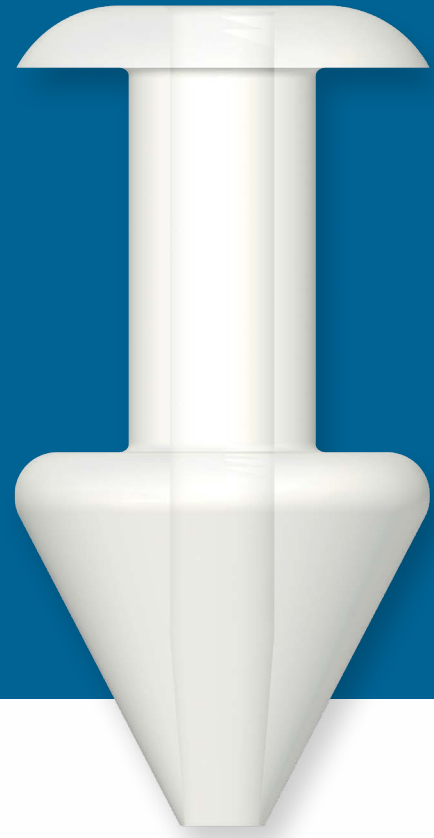

The **VeraPlug™ Flow** is designed to provide a simple and effective means of slowing tear drainage.

- Inner channel reduces but does not eliminate tear flow, providing only **partial occlusion**
- Engineered to perfectly fit the puncta for **excellent retention**
- Low-profile dome for **enhanced patient comfort**
- Proprietary shaft design for **easy insertion** and **proper anatomic fit**



VeraPlug Flow Sterile Preloaded

Individually packaged and preloaded on a sterile, disposable inserter. 1 pair per box.

SKU		SIZE
VFL-1001	VeraPlug Flow Sterile Preloaded - Small	0.4mm to 0.6mm
VFL-1002	VeraPlug Flow Sterile Preloaded - Medium	0.6mm to 0.7mm
VFL-1003	VeraPlug Flow Sterile Preloaded - Large	0.7mm to 0.8mm
VFL-1004	VeraPlug Flow Sterile Preloaded - X-Large	0.8mm to 1.0mm

VeraPlug Flow Bulk Nonsterile

Packaged nonsterile, 1 pair per poly bag. 5 pairs per box. Inserters included.

SKU		SIZE
BVF-1001	VeraPlug Flow Nonsterile Bulk - Small	0.4mm to 0.6mm
BVF-1002	VeraPlug Flow Nonsterile Bulk - Medium	0.6mm to 0.7mm
BVF-1003	VeraPlug Flow Nonsterile Bulk - Large	0.7mm to 0.8mm
BVF-1004	VeraPlug Flow Nonsterile Bulk - X-Large	0.8mm to 1.0mm

Vera180™

Synthetic absorbable lacrimal plugs provide approximately **6 months of treatment.**



Months
OF RELIEF FROM DRY EYE

- Provides extended temporary occlusion lasting approximately **180 days**
- Ideal for treatment of **post-surgical dry eye**, and to determine potential effectiveness of a non-absorbable punctal plug
- Also indicated for use in treating the dry eye components of various **ocular surface diseases**, including contact lens intolerance

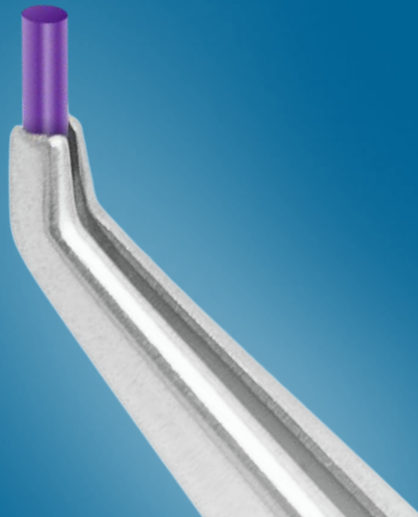

Vera180 Synthetic Absorbable Lacrimal Plugs

Synthetic absorbable lacrimal plugs made of poly-p-dioxanone (PDO). Absorbs in approximately 180 days.

20 PLUGS PER BOX (10 packs of 2 plugs each)

SKU		SIZE
ESK-1002	Vera180 Synthetic Absorbable Lacrimal Plugs (10 Pairs)	0.2mm
ESK-1003	Vera180 Synthetic Absorbable Lacrimal Plugs (10 Pairs)	0.3mm
ESK-1004	Vera180 Synthetic Absorbable Lacrimal Plugs (10 Pairs)	0.4mm
ESK-1005	Vera180 Synthetic Absorbable Lacrimal Plugs (10 Pairs)	0.5mm

2 PLUGS PER BOX

SKU		SIZE
ESK-1002S	Vera180 Synthetic Absorbable Lacrimal Plugs (Single Pair)	0.2mm
ESK-1003S	Vera180 Synthetic Absorbable Lacrimal Plugs (Single Pair)	0.3mm
ESK-1004S	Vera180 Synthetic Absorbable Lacrimal Plugs (Single Pair)	0.4mm
ESK-1005S	Vera180 Synthetic Absorbable Lacrimal Plugs (Single Pair)	0.5mm

Temporary Punctal Occlusion



VeraC7™

Temporary Collagen Inserts lasting **7 to 10 days**

- Ideal for **diagnostic use** in chronic dry eye patients considering permanent punctal occlusion
- Also indicated for extending medication contact time and effectiveness

VeraC7 Collagen Inserts

Collagen punctal inserts for diagnostic use, providing highly effective occlusion in the first 2 to 3 days post-insertion. Absorbs completely in 7 to 10 days. 60 inserts per box (10 packs of 6 inserts each).

SKU		SIZE
CSP-1002	VeraC7 Collagen Inserts (60 inserts)	0.2mm
CSP-1003	VeraC7 Collagen Inserts (60 inserts)	0.3mm
CSP-1004	VeraC7 Collagen Inserts (60 inserts)	0.4mm

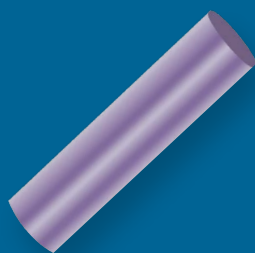

Vera90™

Synthetic Extended Inserts lasting **60 to 180 days**

- Ideal for the treatment of **dry eye following LASIK** or other surgical procedures
- Also indicated for use in treating the dry eye components of various ocular surface diseases

Vera90 Synthetic Extended Inserts

Synthetic extended punctal inserts made of E-Caprolactone-L-Lactide copolymer (PCL). Absorbs in 60 to 180 days. 20 inserts per box (10 packs of 2 inserts each).

SKU		SIZE
ESP-1002	Vera90 Synthetic Extended Inserts (10 pairs)	0.2mm
ESP-1003	Vera90 Synthetic Extended Inserts (10 pairs)	0.3mm
ESP-1004	Vera90 Synthetic Extended Inserts (10 pairs)	0.4mm
ESP-1005	Vera90 Synthetic Extended Inserts (10 pairs)	0.5mm

Dry Eye Diagnostics



BioGlo™

Fluorescein ophthalmic strips for evaluating contact lens fittings, corneal and conjunctival problems and applanation tonometry. CE marked. 100 or 300 individually wrapped sterile strips per box.



Lissamine Green

Ophthalmic test strips for evaluating corneal and conjunctival problems. Unlike Rose Bengal, it is sting-free. 100 individually wrapped sterile strips per box.



TearFlo™

Schirmer-type tear test for measuring and recording tear volume. CE marked. 100 individually wrapped sterile strips per box.

Miscellaneous



Dry Eye Compress

LAC-1000

Featuring HydroHeat™ technology to provide clean, deep-penetrating, moist heat. Microwave for 30 seconds and apply 3-5 minutes a day to relieve dry eye and improve meibomian gland function, or freeze and apply cold to relieve swollen, puffy eyes.



Instruments

Stephens Intracanalicular Plug Forceps

S5-1059

For use in removal of punctal plugs and insertion of collagen and synthetic extended inserts.



Gland Expressor

S5-1057

88mm forceps with closee paddles for use in the expression of the meibomian gland.

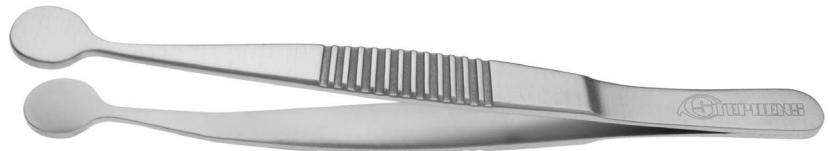

Stephens Meibomian Gland Expressor

S5-1058

Overall length 105mm, paddle length 3.25mm
For use in the expression of the meibomian gland.



Sizing Gauge

S8-1200/S8-1205

0.5mm/0.6mm and 0.7mm/0.8mm for determining the proper size punctal occluder prior to insertion.





Speculums	190
Foreign Body, Curette	191
Manipulator, Hook, Caliper	191
Forceps	193
Needle Holder, Scissors	195
Knives	197

Single-Use



Barraquer Wire Speculum

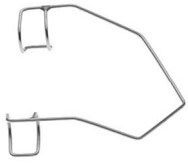

SSD1 1001

Infant, 4mm
Overall Length: 32mm

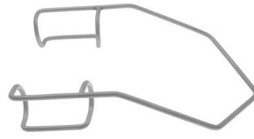

SSD1 1002

Child, 12mm
Overall Length: 39mm

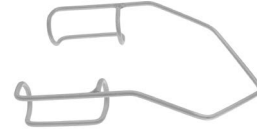

SSD1 1005

Adult, 15mm
Overall Length: 41mm

Barraquer Wire Speculum

Solid Blades

SSD1 1010 Child, 12mm

Overall Length: 35mm

SSD1 1015 Adult, 15mm

Overall Length: 42mm



Kratz Wing Speculum

SSD1 1016

Overall Length: 38mm
Adult, 15mm

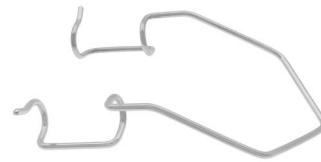

Lieberman Adjustable Speculum

SSD1 1026

Overall Length: 82mm
15mm



Lancaster Speculum

SSD1 1070

Overall Length: 85mm
15mm



Desmarres Lid Retractor

SSD1 1220 #1, 13mm

Overall Length: 133mm

SSD1 1225 #2, 15mm

Overall Length: 144mm



Golf Club Foreign Body Spud

SSD2 1135

Overall Length: 117mm

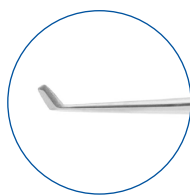

Chalazion Curette

SSD4 1005 1.75mm

Overall Length: 133mm

SSD4 1015 2.5mm

Overall Length: 131mm



Drysdale Nucleus Manipulator

SSD4 1068

Overall Length: 111mm

Paddle Shaped

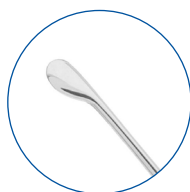

Maumenee-Barraquer

SSD4 1116

Overall Length: 125mm

Vitreous Sweep, Spatula



Schocket Scleral Depressor

SSD4 1231

Overall Length: 135mm



Lester Lens Manipulator

SSD4 1372

Overall Length: 114mm

Angled

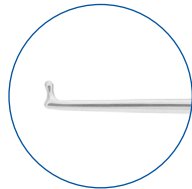

Sinskey II Lens Hook

SSD4 1387

Overall Length: 111mm

Angled



Strabismus Hook

SSD4 1443

Overall Length: 126mm



Braunstein Fixed Caliper

SSD4 1457

Overall Length: 67mm

3.5mm / 4.0mm



Nagahara Phaco Chopper

SSD4 1550

Overall Length: 112mm

Nucleus Splitter, Blunt Tip



Desmarres Chalazion Forceps

SSD5 1025

Overall Length: 91mm
20mm

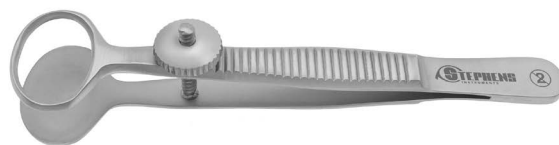

Barraquer Cilia Forceps

SSD5 1085

Overall Length: 108mm

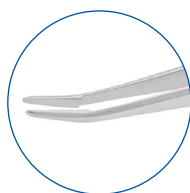

Barraquer Colibri Forceps

SSD5 1120

Overall Length: 70mm
Tying Platform, 0.12mm

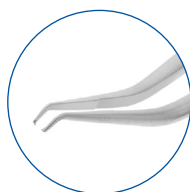

Bonn Forceps

SSD5 1240

Overall Length: 109mm
1x2 Teeth, 0.12mm

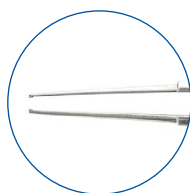

Masket Capsulorhexis Forceps

SSD5 1602

Overall Length: 105mm
Curved

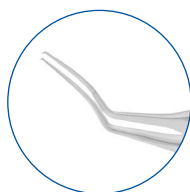

Utrata Capsulorhexis Forceps

SSD5 1603

Overall Length: 105mm

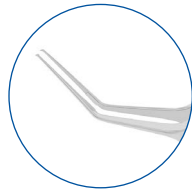

Jaffe Tying Forceps

SSD5 1625

Overall Length: 110mm

Smooth Jaws, 0.3mm

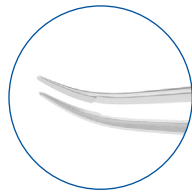

Kelman-McPherson Tying Forceps

SSD5 1630

Overall Length: 106mm

Smooth Jaws, Angled

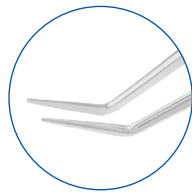

McPherson Tying Forceps

SSD5 1650

Overall Length: 111mm

Straight

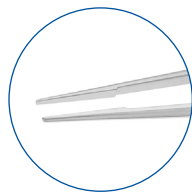

Jewelers Forceps #3C

SSD5 1700

Overall Length: 112mm

#3C, Straight

Short Taper



Jewelers Forceps #5

SSD5 1710

Overall Length: 112mm



Castroviejo Needle Holder

SSD6 1050 Standard Jaws, Straight, With Lock

Overall Length: 142mm

SSD6 1070 Delicate Jaws, Curved, Without Lock

Overall Length: 137mm



Stevens Tenotomy Scissors

SSD7 1085

Overall Length: 115mm

Straight



Castroviejo Corneal Scissors

SSD7 1240

Overall Length: 117mm

Medium Blades, Curved, Blunt

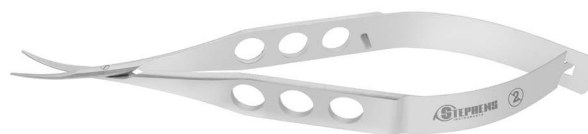

Westcott Tenotomy Scissors

SSD7 1325

Overall Length: 115mm

Standard Blades, Blunt



Vannas Capsulotomy Scissors

SSD7 1370 Straight, Sharp

Overall Length: 82mm

SSD7 1375 Curved, Sharp

Overall Length: 84mm

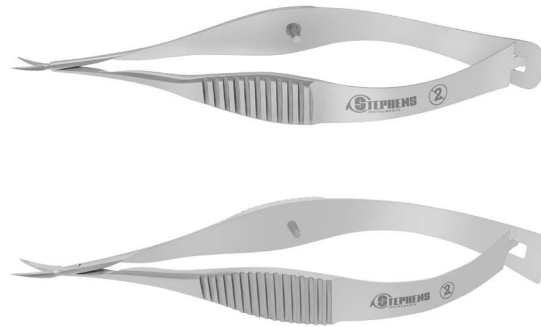

Castroviejo Lacrimal Dilator

SSD8 1015

Overall Length: 137mm

Medium & Fine Tips



Bowman Lacrimal Probe

SSD8 1070

Overall Length: 153mm

00-0



Knives

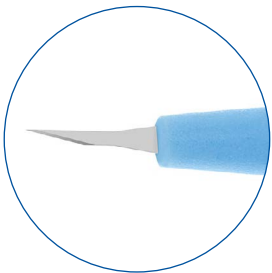

R-1500

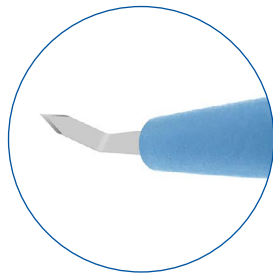

R-5508

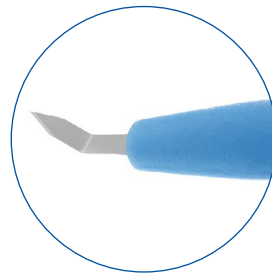

R-5516

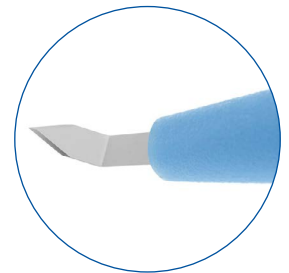

R-5570

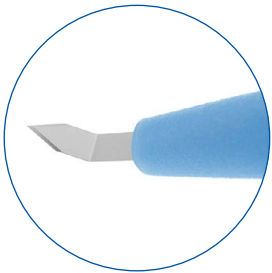

R-5572

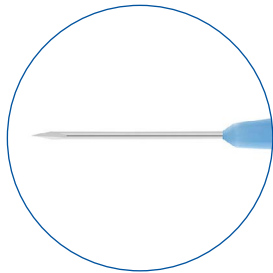

R-5560

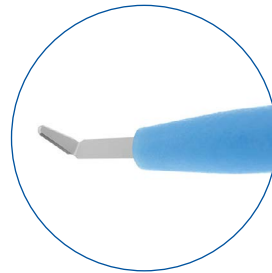

R-9402

KNIVES

R-1500	15 Degree Stab Knife	6 per box
R-5508	2.2mm Angle Slit Knife	6 per box
R-5516	2.8mm Angle Slit Knife	6 per box
R-5570	3.0mm Angle Slit Knife	6 per box
R-5572	3.2mm Angle Slit Knife	6 per box
R-5560	20ga Full Handle MVR Knife	6 per box
R-9402	Crescent Angled Bevel Up Knife	6 per box



Biologics

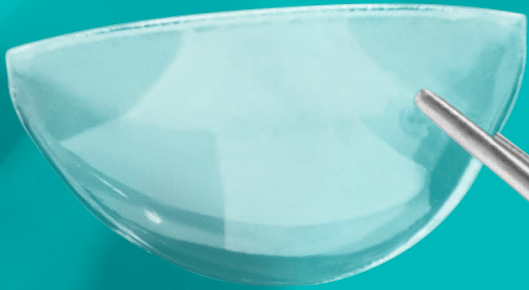

OptiGraft™

Sterile Ophthalmic Allografts

The Premium Choice for Glaucoma and Corneal Applications.

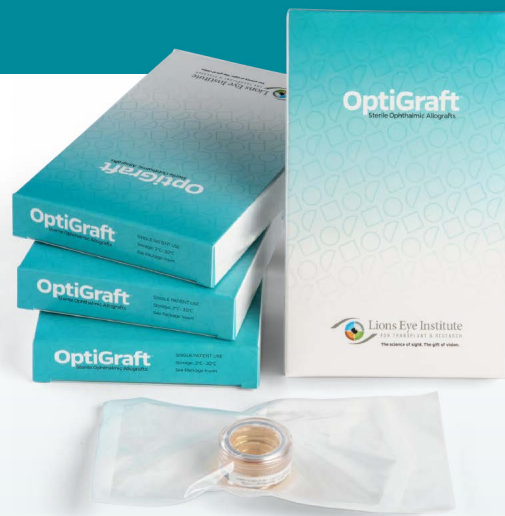

Hydrated, irradiated, sterile tissue has long been the gold standard for ocular patch graft options—its low risk of postsurgical infection or immune rejection and long shelf life are obvious advantages. High operational costs and reimbursement concerns have hampered widespread use until now.

OptiGraft™ sterile ophthalmic allografts offer high-quality, shelf-stable, terminally-sterilized tissue as an affordable option for glaucoma and corneal procedures. In addition to these benefits, the longer shelf life of up to 2 years, ambient storage capability, and specially designed packaging for ease of use make the OptiGraft line a practical option for healthcare providers worldwide.

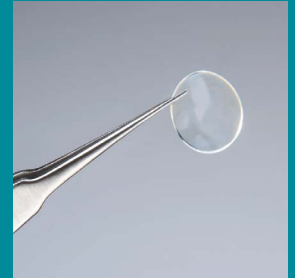
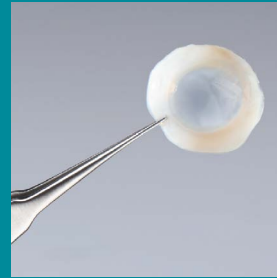
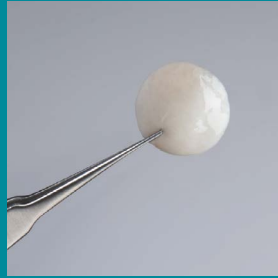

Sterile Patch Grafts for Glaucoma Surgery

- Tube shunt and valve coverage
- Trabeculectomy support
- Structural integrity restoration
- Bleb, scleral buckle repair, and corneoscleral fistul repair

Sterile Cornea for Corneal Surgery

- Corneal Perforation
- Corneoscleral laceration repair
- Trauma and/or Emergency
- Boston keratoprosthesis (KPro)
- Tectonic anterior lamellar keratoplasty (ALK/ DALK)

TISSUE TYPE	SHAPE	SIZE & THICKNESS	TISSUE CODE*
Sterile Cornea		Whole moon, full thickness with scleral rim	V0103/V0106
		Whole moon, split thickness (9mm)	V0131/V0139
Glaucoma Patch Graft		Half-moon, split thickness (9mm X 4.5mm)	V0129/V0137
		10mm sclera disk	V0146/V0154
Sterile Sclera	Anatomical	1/4 sclera	V0151/V0158
	Anatomical	1/3 sclera	V0150/V0157

*Each pair of tissue codes are interchangeable and will provide the same type of graft. List both codes when ordering

- A**
- A/C Maintainer..... 112
 - Adjustable Speculum..... 5–11
 - Adson Forceps..... 56
 - Aebli Angular Scissors..... 86
 - Agricola Retractor 11
 - Air Injection Cannula 111
 - Akahoshi Pre-Chop 74, 128
 - Alfonzo Speculum..... 7
 - Alger Brush..... 15
 - Anis Ball Tip Manipulator 42
 - Anterior Chamber Cannula 104–107
 - Arruga Capsular Forceps 59
 - Arruga Retractor 24
 - Artisan Lens Implantation Forceps..... 71
 - Asymmetrical Forceps..... 132, 134
 - Atkinson Retrobulbar Needle..... 110
 - Ayer Chalazion Forceps..... 42
 - Azar Corneal Scissors 91
- B**
- Baby Jones Towel Clamp..... 74
 - Backhaus Towel Clamp..... 74
 - Bailey Infant & Child Lacrimal Cannula 108
 - Baird Chalazion Forceps 42
 - Baker Orbital Retractor Set..... 25
- BARRAQUER**
- Cilia Forceps..... 45, 124, 193
 - Colibri Forceps..... 46, 49, 193
 - Conjunctiva Forceps..... 55
 - Iris Scissors 93–94
 - Iris Spatula..... 17–18, 20, 191
 - Lenticular Spoon 21
 - Needle Holder 78–79, 83–84, 128–129
 - Speculum..... 4–6
- Beaupre Cilia Forceps..... 46
 - Beaver Blade Handle..... 117
 - Bechert Nucleus Rotator..... 19, 122
 - Berke Ptosis Forceps..... 42
 - Berkeley Double Marker..... 102
 - Beyer Rongeur Forceps..... 76
 - Bi-Manual Handpiece 104
 - Binkhorst Irrigating Hooked Cannula 111–112
 - Binkhorst Lens Forceps 70
- BIOLOGICS**..... 198–201
- Cornea Tissue..... 200–201
 - Sclera Tissue 200–201
 - Tissue..... 200–201
- BISHOP-HARMON**
- Anterior Chamber Irrigator Cannula..... 104
 - Forceps 55
 - Iris Forceps..... 54, 125
- Blade Handle..... 117
 - Blaydes Lens Forceps 70
 - Bock Suture Forceps 61
 - Bonaccolto Utility & Splinter Forceps..... 73
 - Bonaccolto Utility Forceps 76
- BONN**
- Forceps 51–52, 65, 125, 193
 - Iris Hook..... 26
 - Lacrimal Cannula..... 108
- Bores Axis Marker..... 102
 - Bores Incision Spreading Forceps 73
 - Bores U-Shaped Fixation Forceps 58
 - Botvin Forceps..... 53
 - Bowman Lacrimal Probe..... 98, 196
 - Bracken Irrigating Cannula..... 104
 - Bracken Scleral-Fixation Forceps..... 59
 - Braunstein Fixed Caliper..... 35, 192
 - Bunge Evisceration Spoon 24
 - Buratto Flap Protector 40, 123
 - Buratto LASIK Flap Forceps..... 60
 - Buratto LASIK Irrigation Cannula..... 115
 - Burch Fixation Pick 26
- C**
- Caliper..... 39, 123, 192
- CANNULA**
- Air Injection 111
 - Anterior Chamber 104–107
 - Aspirating..... 107–108, 116
 - Bi-Manual..... 104
 - Capsule Polisher 112
 - Cortex 113
 - Cystotome 111
 - DALK..... 117
 - Hydrodissector 114–115
 - Infusion Handpiece 107
 - Iris Retractor..... 113
 - Irrigating 104–107, 111–112
 - I/A Handpiece 114
 - Lacrimal 108–110
 - LASIK..... 115–117
 - Retrobulbar 110
- CAPSULE**
- Elevator/Manipulator..... 19
 - Forceps..... 63
 - Polisher..... 17, 112–114
 - Scissors..... 95–96

CAPSULORHEXIS FORCEPS

- Forceps 62–63, 126, 133, 193–194
- Inamura Forceps 63, 126
- Masket Forceps 63, 126, 193
- Utrata Forceps 62, 126, 133, 194

CASTROVIEJO

- Blade Breaker 15
- Caliper 35, 123
- Capsular Forceps 59
- Colibri Forceps 48, 125
- Corneal Scissors 89–91, 195
- Cyclodialysis Spatula 21, 122
- Keratoplasty Scissors 92
- Lacrimal Dilator 97, 196
- Needle Holder 80–81, 129, 195
- Spatula & Spoon 22
- Speculum 8
- Suturing Forceps 61–62, 126
- Synechia Spatula 21

CHALAZION

- Curette 16–17, 191
- Forceps 42–45, 124, 193

CHANG

- Combination Chopper 37
- Horizontal Microfinger Chopper 37
- Hydrodissection Cannula 114
- Chang-Seibel Chopper 36
- Chopper 35–37, 41, 192
- Cilia Forceps 45–46, 124, 193
- Citelli Rongeur Forceps 77

CLAMP

- Ptosis 42
- Putterman 73
- Towel 74
- Clark Universal Speculum 8
- Cohan Corneal Forceps 50
- Cohan-Vannas Scissors 96
- Colibri Forceps 46–49, 124–125, 193

CONJUNCTIVA

- Clamp 73
- Forceps 54–55
- Scissors 92–94
- Connor Wand 37
- Cook Speculum 8

CORNEAL

- Bi-Fixation 57–58
- Corneal Epithelium Spatula 40
- Forceps 49–51, 77, 134
- Knife 13

- Scissors 89–92, 195
- Tissue 200–201

Corneal Epithelium Spatula-Hockey Stick 40

CORNEOSCLERAL

- Forceps 49–50
- Punch 16
- Cortical Cleaving Hydrodissection Cannula 115
- Crescent Angled Bevel Up Knife 197
- Cross-Action Lens Folding Forceps 70
- Culler Iris Spatula 18
- Culler Rectus Muscle Hook 32
- Curette 16–17, 191
- Cystotome Irrigation Cannula 111

D**DALK**

- DALK Cannula 117
- DALK Scissors 88
- Dastoor Pupil & Iris Repositor 21
- Dastoor Superior Rectus Forceps 60
- Depressor 24–25, 192

DESMARRES

- Chalazion Forceps 43, 124, 193
- Lid Retractor 10, 191
- Diffenbach Serrefine 75
- Dilator 97–98, 196
- Dimarco Lens Folding-Insertion Forceps 72
- Dix Foreign Body Spud 13

DMEK

- Endothelium Forceps 51
- Tissue Prep Forceps 66
- Dodick Nucleus Cracker 73
- Dolmetsch Ptosis Clamp 42
- Double Ended Femtosecond Spatula 41
- Dressing Forceps 55

DRY EYE

- Compress Mask 186
- Silicone Punctal Plugs 176–181
- Temporary Punctal Plugs 182–185
- Drysdale Nucleus Manipulator 18, 191
- DSAEK Corneal Forceps 134

E

- Eckhardt End Gripping Forceps 132
- Ellis Foreign Body Spud 14
- Elschnig Cyclodialysis Spatula 21
- Elschnig Fixation Forceps 58
- Endothelial Stripper 40
- Entropian Forceps 43

ENUCLEATION

Scissors	88
Spoon	24
Erhardt Lid Forceps	43

F

Fasanella Lacrimal Cannula	108
Fascia Needle	12

FEMTO

Chopper	41
Spatula	41
LRI Enhancement Forceps	61
Fenzl Lens Manipulating Hook	28, 30
Fink Retractor	11
Fischer-Arlt Iris Forceps	54

FIXATION

Forceps	56–59, 77–78
Hook	26
Pick	26
Ring	10, 122
FlexFit Punctal Plug	176–177
Flieringa Fixation Ring	10

FORCEPS

Asymmetrical	134
Bi-Fixation	57–59
Capsule	63
Capsulorhexis	62–64, 126–127, 133, 193–194
Chalazion	42–45, 124, 193
Cilia	45–46, 124, 193
Colibri	46–49, 124–125, 193
Conjunctiva	54–55
Corneal	49–51, 77
Dressing	55
Entropion	43
Fixation	56–59, 77–78
Foreign Body	73
Hemostat	75
ILM	134
Incision Spreading	73
Intraocular / IOL	70–71, 133–134
Iris	52–54, 125
Jewelers	68–69, 194–195
LASIK	60
Lens	70–71, 133–134
Lid	43
Meibomian Expressor	44
Mosquito	75
Muscle	72–73
Nucleus	73–74
Plug	45, 60, 187
Pre-Chop	74, 128

Ptosis	42
Retinal	132–135
Rongeur	76–77
Suturing	61–62, 126
Superior Rectus	59, 60
Tissue	56, 75–77
Titanium	124–128
Tying	64–68, 78, 127–128
Utility	73, 75–76

FOREIGN BODY

Burr	14–15
Forceps	73
Needle	13
Spud	13–14, 191
Francis Chalazion Forceps	44, 124
Francis Foreign Body Spud	14
Fugo Z-Hook Lens Manipulator	29
Fukasaku Lasik Spatula	38

G

Galand Lens Manipulating Hook	30
Galin Lens Spatula	20
Gaskin Fragment Forceps	63
Gass Punch	16
Gill Corneal Knife	13
Gill Iris Forceps	53
Gills Colibri Forceps	47
Gills Irrigating Cannula	105
Gills Vannas Scissors	96
Gills/Welsh Lens Loop	22
Gimbel Lasik Irrigation Cannula	116
Gimbel Lasik Polishing Cannula	116
Girard Corneoscleral Forceps	49
Girard Synechia Spatula	19
Goldstein Retractor	11
Golf Club Foreign Body Spud	13, 191
Gradle Cilia Forceps	46
Graefe Fixation Forceps	56
Graefe Iris Forceps	52
Graefe Muscle Hook	32
Graether Collar Button	27
Graether Collar Button Iris Retractor Cannula	113
Grandon-Barraquer Speculum	6
Grayson/Kuglen Double-Ended Manipulator	28
Green Fixation Forceps	57
Green Muscle Hook	34
Green Spatula	34
Guimaraes LASIK Spatula	38
Gulani Lasik Cannula	116
Gunderson Muscle Forceps	73

H

Haab Scleral Knife	13
Harms Colibri Forceps.....	48
Harms Trabeculotomy Probe	96
Harms Tying Forceps.....	64
Harris-Sinsky Lens Hook.....	29
He Hook Chopper	36
Healon Aspirating Cannula.....	107
Heart-Shaped Vectis Irrigation Cannula	106
Heath Chalazion Forceps.....	44
Hemostat.....	75

HENDERSON

Degree Gauge.....	103
LRI Axis Marker	103
Pre-Operative Alignment Marker.....	103
Toric IOL Marker	104
Hersch Lasik Flap Positioner Cannula.....	116
Herzing LASIK Elevator/Retractor	39
Hirschman Iris Hook.....	27
Hirschman Irrigating Cannula.....	105
Hirschman Lens Spatula	20
Hoffer-McPherson Corneal Bi-Fixation Forceps	57
Hoffer-McPherson Corneal Forceps.....	50
Hoffman-Polack Corneal Bi-Fixation Forceps.....	58

HOOK

Fixation	26
Iris.....	25-28
Lens.....	28-31, 123, 192
Muscle	32-34
Scleral.....	26
Strabismus.....	34, 192
Tenotomy	32
Utility.....	39
Horizontal Cutting Scissors.....	135
Humer Lens Folding Forceps.....	71, 128
Hunt Chalazion Forceps	44
Hyde Corneal Forceps.....	50
Hydrodissection Cannula	114-115

I

ILM Peeling Forceps	134
Inamura Capsulorhexis Forceps.....	64, 126
Infusion Hand Piece	107
IOL Cutting Scissors.....	129, 135
IOL Holding Forceps.....	133-134

IRIS

Cannula	113
Forceps	52-54, 125
Hook.....	25-28
Scissors	84-86, 94
Spatula.....	17-18, 21, 122

Irrigation Cannula	105-111, 115-116
--------------------------	------------------

J

J Shaped Hydrodissector.....	115
Jaeger Lid Plate.....	10

JAFFE

Lens Spatula	20
Needle Holder	81-82
Stitch Scissors	94
Tying Forceps.....	65, 194
Wire Retractor	9
Jaffe-Maltzman Lens Hook	30
Jameson Muscle Forceps	72
Jameson Muscle Hook.....	33
Jensen Posterior Capsule Polisher	112
Jewelers Forceps.....	68-69, 194-195
Josephberg-Besser Scleral Depressor.....	25

K

Kalt Needle Holder	82
Kansas Nucleus Fragment Forceps	64
Kansas Nucleus Trisector	35
Katzen LASIK Flap Unzipper.....	40, 123
Katzin Miniature Scissors.....	92
Keislar Lacrimal Cannula.....	109
Kelly Descemet Membrane Punch.....	16
Kelman Cystotome Knife Cannula.....	111
Kelman Lens Holding & Manipulating Forceps	70
Kelman-McPherson Forceps	51
Kelman-McPherson Tying Forceps.....	65, 127, 194
Kerichoff Aspiration & Irrigation Cannula	113
Kerrison Rongeur Forceps	77
Kimura Platinum Spatula	22
Kirby Expressor Hook & Loop.....	33
Kirby Intracapsular Lens Loop.....	23
Kirby Iris Spatula.....	18
Kirby Muscle Hook.....	33
Knapp Retractor.....	12
Knapp Strabismus Scissors.....	86, 88

KNIFE

Corneal.....	13
Disposable	197
Scleral.....	13
Knolle Irrigating Cannula.....	105
Knolle Nucleus Spatula	19
Knolle-Pearce Vectis Cannula.....	105
Koch Phaco Manipulator.....	20
Koch Stop And Chop Manipulator.....	36
Kraf Capsule Tag Forceps.....	63
Kratz Capsule Wall Scraper	112
Kratz Irrigating Cannula.....	106

Kratz Wing Speculum.....	6, 190
KU LASIK Flap Elevator/Manipulator.....	39
Kuglen Iris Hook & Lens Manipulator.....	27–28
Kuhnt Fixation Forceps.....	57

L**LACRIMAL**

Cannula.....	108–111
Dilator.....	97–196
Probe.....	98–99, 196
Lacriviera.....	175
Lambert Chalazion Forceps.....	45
Lancaster Speculum.....	9, 190
Large Ring Scissors.....	85

LASEK/LASIK

Alcohol Well.....	102
Cannula.....	115–117
Elevator/Manipulator.....	39
Flap Forceps.....	60
Flap Protector.....	40, 123
Flap Retreatment.....	38–39, 124
Flap Unzipper.....	40, 123
Spatula.....	38–39
Speculum.....	4

LENS

Forceps Folding.....	70–72, 128
Forceps Holding.....	70–72, 128, 133–134
Hook.....	29–30, 123, 192
Loop.....	22–24, 122
Manipulator.....	27–30, 123
Spatula.....	20
Lester Fixation Forceps.....	57
Lester Lens Manipulator.....	28, 123, 192
Lester-Burch Speculum.....	9
Lewicky Lens Manipulating Hook.....	29
Lewis Lens Loop.....	23

LID

Chalazion Forceps.....	42–45, 124, 193
Jaeger Plate.....	10
Retractor.....	4, 9–12, 24–25, 191

LIEBERMAN

Forceps.....	68
Speculum.....	5–7, 122, 190
Livernois Lens Forceps.....	70
Loop, Lens.....	14, 22–24, 122
Lordan Chalazion Forceps.....	45
LRI Gravity Marker.....	103
Lund Micro Keratoplasty Scissors.....	92

M

Macgregor Conjunctiva Forceps.....	54
Machat LASIK Retreatment.....	39
Manhattan Eye & Ear Forceps.....	67

MANIPULATOR

Elevator.....	12, 38–39
Lens.....	27–31, 123, 192
Nucleus.....	18–19, 122, 191
Phaco.....	20, 35–37
Manson Double Ended Hook.....	34

MARKERS

Axis.....	100, 102
Optical Zone.....	100–101
PRK.....	102
Radial.....	101
Stamp.....	102–103
Toric.....	103–104

Masket Capsulorhexis Forceps.....	63, 126, 193
Maumenee Colibri Forceps.....	48
Maumenee-Barraquer Spatula.....	20, 191
Maumenee-Park Speculum.....	9
Maunoir Iris Scissors.....	86
Mayo Scissors.....	87
Mccannel Iris Suture Needle Guide.....	34
Mccullough Utility Forceps.....	76
Mcquire Corneal Scissors.....	90

MCPHERSON

Forceps.....	50–51, 65–66, 127, 194
Needle Holder.....	83
Scissors.....	92, 94
Mcreynolds Spatula & Hook.....	33
Meibomian Gland Expressor.....	44
Mendez Axis Finder.....	100
Mendez LASIK Flap Forceps.....	60
Meyerhoefer Chalazion Curette.....	16
Microsurgical.....	130–135
Micro Gripping Forceps.....	133
Micro Needle Holder.....	83
Micro-Incision Capsulorhexis Forceps.....	127
MICS Capsulorhexis Forceps.....	64, 127
Miniature Corneal Scissors.....	90, 92, 94
Moody Fixation Forceps.....	56
Morrison Lens Loop & Probe.....	22
Mosquito Hemostat.....	75
Muldon Lacrimal Dilator.....	97
Muller Retractor.....	11
Muscle Forceps.....	72–73
Muscle Hooks.....	32–34

N**NAGAHARA**

- Disposable Phaco Chopper 192
- Horizontal Chopper 35

Nasal Speculum 12

Naugle-Fleming Knurled Dilator 98

Needle Driver 78–84

NEEDLE HOLDER 78–84

- Needle Point Stitch Scissors 85
- New Orleans Lens Loop 23, 122
- Newell Lid Retractor, Pair 4
- Nichamin Lasik Flap Positioner Cannula 117
- Nichamin Quick Chop Verticle Chopper 36
- Nightingale Curette 17

NUCLEUS

- Cannula 114
- Chopper 31, 36–37, 192
- Cracker 73–74
- Forceps 64
- Manipulator 18–19, 122, 191
- Spatula 19
- Splitter 31, 36–37, 74

O

Obstbaum Synechiaie Spatula 20

O’Conner Tenotomy Hook 32

Oculoplastic Set 156

Open Ended Curette 17

Osher Nucleus Splitter 31

Osher Superior Rectus Forceps 59

Osher Utility Hook 39

Osher Y-Hook IOL Manipulator 31

P

Paton Double Spatula 22

Paton Tying Forceps 68

Paufique Suture Forceps 67

Pearce J-Shaped Hydrodissector 115

Pearce Nucleus Hydrodissector 114

Pettigrove PRK Marker/Spatula 102

PHACO

- Chopper 31, 36–37, 192
- I/A Handpiece 114
- Manipulator 20
- Pre-Splitter 74
- Splitter 31, 36

Pierse Forceps 49, 50, 77–78

Pigtail Probe 98

Pisacano Nucleus Rotator 18

Plastic Sterilization Tray 118–119

Polisher, Capsule 112

Pre-Chop, Phaco 74, 128

PROBE

- Lacrimal 97–99
- Trabeculotomy 96

Protector, Flap 40, 123

Pterygium Brush 15

Ptosis Forceps 42

PUNCH

- Corneoscleral 16
- Membrane 16

Punctal Dilator 97–99, 196

Punctal Gauge 99

Punctal Plugs 174–185

Pupil Repositor 21

Putterman Muscle Conjunctival Clamp 73

Q

Quick Chop 36–37

R

Radial Marker 101

Rainin Air Injection Cannula 111

Rainin Lens Hook 29

Reiss Corneoscleral Punch 16

Rentsch & Boat Hook & Lens Manipulator 29

Retinal 130–135

RETRACTOR

- Iris 113
- Lacrimal 11
- Lid 4, 9–12, 191
- Orbital 10, 24–25

Retreatment, LASIK 38–39, 41, 124

Retrobulbar Injection Cannula 110

Reverse Simcoe I/A Unit 113

Reverse Sinsky Hook 31

Ring, Fixation 10, 122

Rolf Lacrimal Sac Probe 98

Rosen Phaco Splitter 36

Ruler 35

S

Sattler Muscle Forceps 72

Sauer Speculum 7

Sauer Suture Forceps 67

Sauter Nucleus Hydrodissector 114

Scheie Anterior Chamber Cannula 107

Schepens Orbital Retractor 25

Schepens Scleral Depressor 25

Schocket Scleral Depressor 24

SCISSORS

Capsulotomy.....	95–96
Conjunctiva	92, 94
Corneal.....	89–92
DALK.....	88
Enucleation	88
Iris.....	84–86, 94
Keratoplasty.....	92
Retinal.....	135
Stitch.....	85, 93–94
Strabismus.....	86–88
Tenotomy.....	87, 93–94
Utility.....	85, 87
Scleral Depressor	24–25, 192
Scleral Hook	26
Scleral Plug Forceps.....	60

SEIBEL

Chopper.....	36–37
Intralase.....	38, 41, 124
Seipser Endocapsular Controller.....	19
Serrated Gripping Forceps.....	133
Serrefine Clamp.....	75
Shahinian Cannula.....	114
Sheets Irrigating Vectis Cannula.....	107
Sheets Micro Hook.....	27

SHEPARD

Forceps.....	66, 71
Marker.....	100
Shepard-Castro Corneal Scissors.....	91
Shepard-Hoffer Optic Zone Marker w/ Cross Hairs.....	100
Schocket Scleral Depressor.....	24, 192
Silicone Bulb.....	104

SIMCOE

Cannula.....	113–114
Lens Loop.....	24
Simpson Lacrimal Dilator.....	97
Single-Use Instruments.....	188–197

SINSKEY

Forceps.....	67
Hook.....	30, 31, 192
Titanium.....	123
Skeel Chalazion Curette.....	17

SLADE, LASIK

Cannula.....	115
Flap Spatula.....	38
Retreatment.....	38
Speculum.....	4
Slit Knife.....	197
SMILE Double Ended Dissector.....	41

Snellen Lens Loop.....	23
Solomon Femto Chopper.....	41

SPATULA

Cyclodialysis.....	21, 122
Double-Ended.....	21–22, 33–34
Femtosecond.....	41
Flap/LASIK.....	38, 41, 124
Iris.....	17–18, 122
Lens.....	20
Nucleus.....	19
SMILE.....	41
Synechiae.....	20–21
Vitreous.....	20, 191

SPECULUM

Infant.....	4, 7–8, 190
Irrigating.....	6
Nasal.....	5–6, 12
Temporal.....	4–9, 122, 190

SPOON

Enucleation.....	24
Evisceration.....	24
Lenticular.....	21
Spoon & Spatula.....	22
Spud.....	13–14, 191
Stab Knife.....	197

STEPHENS

Stephens A/C Maintainer.....	112
Stephens Bi-Fixation Forceps.....	58–59
Stephens Bi-Manual Handpiece.....	104
Stephens Blade Breaker.....	15
Stephens Capsulotomy Forceps.....	63
Stephens Cilia Forceps.....	46
Stephens Corneal Forceps.....	49
Stephens DALK Scissors.....	88
Stephens Eye Loop & Magnet.....	14
Stephens Intracanalicular Plug Forceps.....	45
Stephens Irrigating Speculum.....	6
Stephens Lens Folding Forceps.....	70
Stephens Lens Insertion Forceps.....	71
Stephens Meibomian Gland Expressor.....	44
Stephens Needle Holder.....	82, 129
Stephens Phaco Nucleus Splitter.....	31
Stephens Phaco Pre-Splitter.....	74
Stephens Scissors.....	95
Stephens Soft IOL Insertion Forceps.....	71
Stephens Toric IOL Bubble Level Marker.....	104
Stephens Tying Forceps.....	68
Stephens-Gills Scissors.....	95
Stephens-Vannas Scissors.....	95
Stephens-Westcott Conjunctiva Scissors.....	94

Sterilization Tray.....	118–119
Stern-Gills Vannas Scissors.....	96
Stevens Corneoscleral Forceps.....	50
Stevens Tenotomy Hook.....	32
Stevens Tenotomy Scissors.....	86–87, 195
Stevenson Retractor.....	11

STRABISMUS

Hook.....	34, 192
Scissors.....	86–88
Suture Forceps.....	61–62, 67–68
Swiss Muscle Forceps.....	72

T**TENNANT**

Forceps.....	49, 67, 128
Hook.....	31
Nucleus Manipulator.....	19
Titanium.....	128
Tenzel Double Ended Periosteal Elevator.....	12
Thornton Fixation Ring.....	10, 122
Thornton Low Profile Marker.....	101
Thorpe Corneal Forceps.....	51
Thorpe Fixation Forceps.....	58
Tissue Forceps.....	54–56, 66, 77

TITANIUM 120–129

Caliper.....	123
Capsulorhexis.....	126–127, 133
Flap.....	123–124
Forceps.....	124–128, 133–134
Hook.....	123
Manipulator.....	122–123
Needle Holder.....	128–129
Ring.....	122
Spatula.....	122
Speculum.....	122

Tooke Corneal Knife.....	13
Towel Clamp.....	74
Trays.....	118–119
Trisector, Nucleus.....	35

TROUTMAN

Forceps.....	49, 60
Needle Holder.....	83–84
Scissors.....	89, 92
Trabeculotomy Probe.....	96
Tying Forceps.....	61–62, 64–68, 127–128, 194
Tyrell Iris Hook.....	25

U

Universal Scissors.....	91
Universal Speculum.....	5, 8
Utility Forceps.....	73
Utrata Capsulorhexis Forceps.....	62–63, 126, 133, 194

V

Vannas Capsulotomy Scissors.....	95–96, 196
Vera180 Synthetic Absorbable Lacrimal Plugs.....	182–183
Vera90 Synthetic Extended Inserts.....	185
VeraC7 Collagen Inserts.....	184
VeraPlug Punctal Plugs.....	174–181
Vidaurri LASIK Flap Irrigator.....	117

W

Weaver Curette.....	17
Weber Lens Loop.....	23
Wells Enucleation Spoon.....	24
Welsh Flat Olive Tip.....	105
West Irrigating Cannula.....	107
West Lacrimal Cannula.....	110
West Lacrimal Chisel.....	12

WESTCOTT

Stitch Scissors.....	93–94
Tenotomy Scissors.....	92–94, 195
Wiese Chalazion Forceps.....	45
Wilder Lacrimal Dilator.....	97
Wilder Serrated Lens Loop.....	23
Williams Lacrimal Bulbous Probe.....	99
Williams Speculum.....	9
Wills Eye Foreign Body Spud & Burr.....	14
Wills Eye Irrigating Cannula.....	107
Wills Hospital Utility Forceps.....	76
Wills Retractor.....	12

WIRE

Retractor.....	9
Speculum.....	4–7, 122, 190
Wright Fascia Needle.....	12

XYZ

Ziegler Lacrimal Canal Probe.....	98
-----------------------------------	----

Our Commitment to Innovation

Do you have an innovative idea to develop and bring to life?

Stephens Instruments' design and development team is here to help.

Please contact info@stephensinst.com for more information.





No part of this catalog may be reproduced, edited, copied or disseminated in any form without prior written consent of Stephens Instruments.

Due to the constant technological progress all product specifications and illustrations are subject to change without notice.

VeraPlug™, SafeSite™, VeraPlug FlexFit™, etc. are trademarks of Stephens Instruments.



Toll Free (USA) **800.354.7848**

Stephens Instruments
2500 Sandersville Rd
Lexington KY 40511 USA
info@stephensinst.com

stephensinst.com